

aerosmith®

GT60LI CONCRETE GAS TOOL

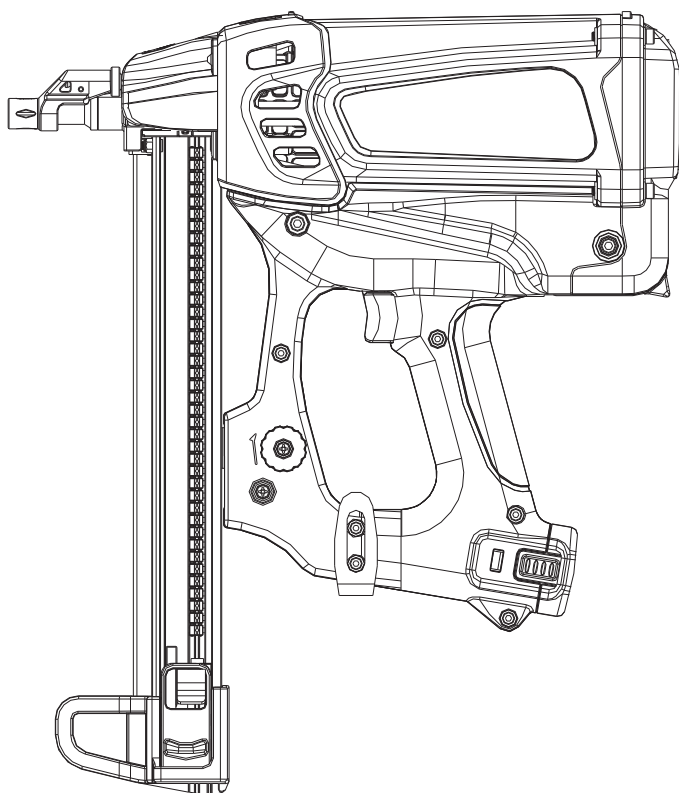

OPERATIONAL MANUAL

1 - OPERATIONS

A. Charging

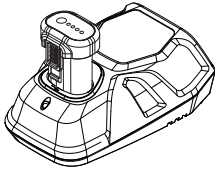

Steps:

1. Plug the battery charger into the proper AC voltage source, green light will be flashing.
2. Insert the battery into charger, red light will alight indicating the battery is charging.
3. It takes about 60 minutes for charging.
4. When fully charged, green light will remain alight.
5. After charging, unplug the charger from the power source.

- If orange light is blinking, remove the battery cartridge and plug again.
- If this happens continuously, the battery cartridge or charger may be damaged. Consult authorized serviceman for replacement of new battery cartridge.

NOTE:

- Never attempt to open the charger or battery cartridge.
- The battery charger is for charging specific battery pack. Never attempt to charge battery pack from other manufacturer's battery cartridge. Unsuitable battery cartridges may cause fire that causes injury.
- When the battery charger is being used, keep out of direct sunlight.
- To get better cooling effect, keep the exhaust area clean.

B. Installing and removing the battery

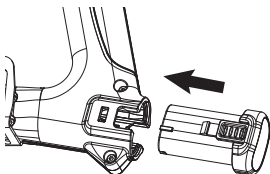

Steps:

1. Empty fasteners from the magazine and make sure the trigger is not pulled while installing

the battery.

2. To install the battery, insert the battery cartridge until hearing a "click".

3. To remove the battery, grip the buttons on both side of battery cartridge and pull out.

C. Battery Light Indicator

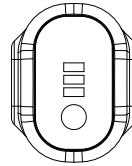

LED	Battery Level
All LEDs	100%
1 Green and 1 Red LED	50%
1 Red LED	25%

NOTE:

- After using the tool, remove the battery from the tool to prevent the tool from being fired.

D. Preparing the fuel cell

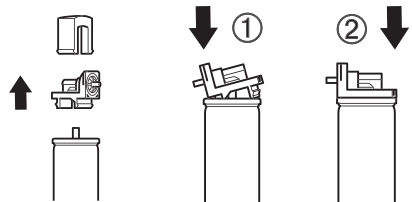

Caution !

- Never attempt to use fuel cell from other manufacturer.
- Do not remove the cap when it is unused.
- Never drill a hole on the fuel cell.
- Do not inhale the gas. Breathing in the gas could cause sleepiness, dizziness or nausea.
- The fuel cell is not refillable, do not attempt to refill the gas.

Steps:

First ensure to use the correct colour valve, Please refer to the technical specifications.

1. Detach the cap, attach the valve by pushing in the front edge.

2. Pushing the rear edge until it has “clicked”.

NOTE:

- Make sure the fuel cell valve is attached firmly, if not, gas leakage may occur and create hazards to users and bystanders.

E. Installing/Removing fuel cell

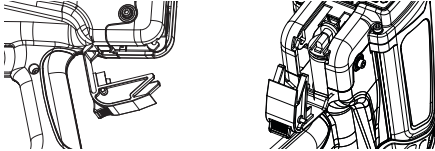

Caution !

- Make sure the trigger is not held while inserting fuel cell.
- Empty fasteners in the magazine before installing fuel cell.
- Do not press on the surface ground while installing.

Steps:

1. Push up and pull to open the fuel door.
2. Insert the fuel cell, direct the jet nozzle into the adaptor.
3. Put the can door over the valve and push it down to latch.
4. For removing fuel cell, reverse the above steps.

F. Loading/Unloading the pins

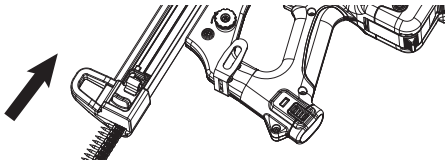

Caution !

- Make sure the trigger is not held while loading the pins.
- Do not press on the surface ground while loading.

Steps:

1. Load the pins into the slit in the rear of the magazine until they reach in front of the nail stopper.
2. Pull the follower holder to the bottom of the magazine and release gently.

3. For removing the pins, pull the follower to the bottom and allow the nails to slide to the nail stopper.

4. Press the nail stopper behind the channel and remove the pins from magazine channel.

G. Driving the pins

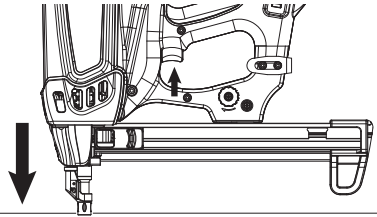

Caution !

- Please READ and UNDERSTAND the section “General Safety Instructions” for personal and working environment safety.
- If you spot any abnormality about the tool, contact nearest authorized serviceman for inspection and repairing.

Steps:

1. Press the Nose of the contact arm against working surface (90° against the surface) firmly until you hear the fan motor is working.
2. Pull the trigger, the pins are driven to the object.
3. Release the trigger and lift the tool.

H. Cleaning jam

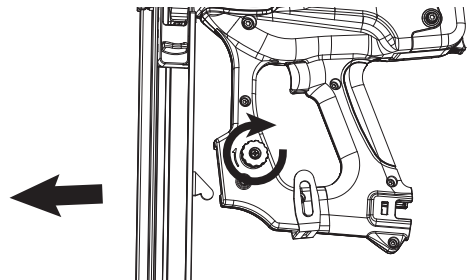

Jamming of pins could be evident if users cannot drive the fasteners properly, try following steps in subsequent order.

Caution !

- Place the tool on a flat surface prior to releasing the magazine, magazine may pop

off suddenly.

- Read previous sections to fully understand battery cartridge installation/removal and unloading fasteners.

Steps:

1. Remove the pins, fuel cell and battery from tool.
2. Pull the knob and rotate clockwise to release magazine channel.
3. Clean any residue along the driving path in the nose piece and pin guide.
4. To install the magazine, first engage the magazine in the slot of the nose piece.
5. Push the connecting plate into the handle until it “clicks”.

NOTE:

- Do not release the magazine with fasteners inside. The follower may pop the pins out and cause injury.
- Wear safety goggles, the jammed fastener may jump out and hurt the user.

I. Adjust the driving depth

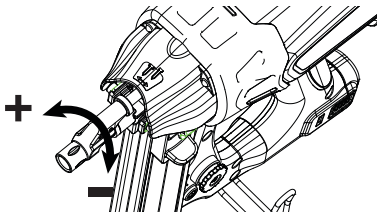

Caution !

- Please READ and UNDERSTAND the section 1 “General Safety Instructions” for personal and working environment safety.
- Never press the pin guide by bare hand or by any parts of the body.
- Never point the tools at anybody.
- Only pull the pin guide to separate the pin lock

Steps:

1. Remove the pins, fuel cell and battery attached on the tool.
2. Adjust the knob clockwise to increase the driving depth, or vice versa.

J. Cleaning Filter

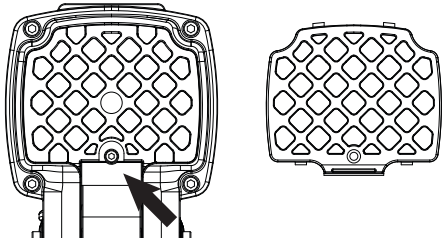

The filter at the back of the tool acts crucially to suck in air into the chamber. For maintaining the best performance of the tool users should always keep it clean.

1. Unscrew the socket screw on the filter.
2. Take out the filter and clean the mesh with brush or air.
3. Put the filter on the machine and fasten with the socket screw.

NOTE:

- Do not attempt to use water to clean the mesh. The cover and mesh must be dry when operating the tool. If wet it may easily cause malfunction to the tool.

K. Regular Maintenance

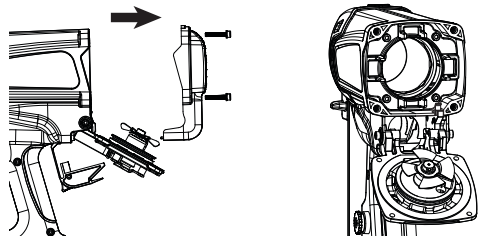

Aerosmith gas tool allows user to perform regular maintenance easily. It helps maximizing the performance and durability of the tool.

1. Unscrew 4 socket screws and remove the head cover.
2. Pivoting the cylinder head.
3. Now you can perform cleaning for crucial parts including spark, fan blade, cylinder with decarbonizer spray.
4. Wipe them clean completely, lubricate and reassemble.

2 - TROUBLESHOOTING



WARNING:

To reduce the risk of serious personal injury, ALWAYS unload the battery, the pins and fuel cell from the tool before all repairs.

A. Battery/Charger Problems

SYMPTOM 1

Battery Cell does not appear to accept charge. Green charger light does not come on after several hours.

Possible reasons	Services
Inoperative indicator lights on charger.	Try Battery in tool after 1 hour on charge cycle. If tool functions properly charger lights are not working correctly. Replace charger, or monitor time to ensure Battery Cell has adequate time for recharging. It's normal for Battery to feel warm after properly charging.
Damaged charger.	Discontinue use immediately and unplug from power source. Replace charger and tag or dispose of charger to prevent accidental reuse or connection to power source.

SYMPTOM 2

Red LED on charger is blinking.

Possible reasons	Services
Battery is hot.	Remove battery from charger and allow to cool. Inspect battery charger and cartridge.

SYMPTOM 3

Orange LED on charger is blinking.

Possible reasons	Services
Charger damaged.	Replace Charger.

B. Normal Stage of Operation

SYMPTOM 1

Fan does not run.

Possible reasons	Services
Battery is not charged.	Charge Battery according to Operating Manual.
Battery Terminals or Handle battery contacts are oily, dirty, or corroded.	Clean Battery Cell terminals Clean Handle Battery Cell contacts as required.
There is electrical short somewhere.	The tool must be looked into by Authorized Serviceman.

SYMPTOM 2

Fan does not run, or runs slower than normal.

Possible reasons	Services
Battery is discharged.	Charge Battery Cartridge.

SYMPTOM 3

Fan runs intermittently.

Possible reasons	Services
Battery is loose or contacts are bent.	Snap battery back into its locked position. Bend contacts back into proper position by Authorized Serviceman.

C. Pre-Combustion/Combustion Stage of Operation

SYMPTOM 1

Contact Arm does not depress fully, tool does not operate.

Possible reasons	Services
Lockout Bar is stuck in lockout position.	Check if there is not enough pins in the channel, load extra pins according to Operating Manual.
The nose piece is bent, or the channel is stuck with dirt.	Inspect if the nose piece and channel is clean. If it is damaged, consult authorized serviceman for repair and replacement of the parts.
Follower holder positions wrongly at the top of the magazine strip.	Slide the follower holder to the bottom and release gently.
Cylinder head O-Ring pinched.	Contact authorized serviceman for repair.
Jammed fasteners.	Clear jam according to User Manual.

SYMPTOM 2

Failure to install fasteners to nose piece.

Possible reasons	Services
Piston positioned wrongly.	Return piston to original position with a rod or screwdriver.
O-Ring is damaged and causing leakage of gas.	Contact authorized serviceman for repair.
Damaged valve plate or reed of the cylinder body.	Contact authorized serviceman for repair.

SYMPTOM 3

Tool will not cycle - fan runs.

Possible reasons	Services
Fuel Cell is empty.	Replace Fuel Cell.
Spark does not occur.	Contact authorized serviceman for repair.

SYMPTOM 4

Fail to drive fasteners.

Possible reasons	Services
Water vapour surrounding spark causing short circuit.	Dry the spark area or contact authorized serviceman for repair.
Sealing ring damaged.	Contact authorized serviceman for repair.
Piston guide stuck with dirt.	Contact authorized serviceman for repair.

D. Power/Exhaust Stage of Operation

SYMPTOM 1

Tool operates properly, but fasteners do not drive fully.

Possible reasons	Services
Battery is discharged.	Charge battery.
Fuel Cell is low.	Replace fuel cell according to User Manual

SYMPTOM 2

Tool operates, but no fastener is driven.

Possible reasons	Services
------------------	----------

Fastener strip may be binding.	Use only fasteners meeting designated specifications.
Follower holding wrong at the top of the pin strip.	Slide follower holder gently to the bottom and release to reset the pin strip in the magazine.
Jammed fasteners	Clear jam according to User Manual.

SYMPTOM 3

Operation of the tool is not stable.

Possible reasons	Services
Fuel Cell is low.	Replace fuel cell according to User Manual.
Spark Plug wire is loose.	Contact authorized serviceman for repair.
Filter element is dirty, causing tool to overheat.	Remove filter element and clean according to User Manual.
Tool sleeve or O-Rings are dirty.	Contact authorized serviceman for repair.

SYMPTOM 4

Unstable performance.

Possible reasons	Services
Built-up dirt and debris inside cylinder	Contact authorized serviceman for repair.

SYMPTOM 5

Diminishing power.

Possible reasons	Services
Damaged piston or cylinder.	Contact authorized serviceman for repair.

E. Returning/Purging Stage of Operation

SYMPTOM 1

Tool operated and drove fastener, but piston did not return to up position.

Possible reasons	Services
Mushrooming of Piston Tip.	Contact authorized serviceman for repair.
Exhaust ports on the sleeve are dirty or clogged	Contact authorized serviceman for repair.
Tool (Sleeve) or O-Rings are dirty.	Contact authorized serviceman for repair.

SYMPTOM 2

Combustion Chamber does not drop after tool cycles.

Possible reasons	Services
Contact arm is bent, or tool is dirty.	Clean tool or replace contact arm as require

3 - COPYRIGHT

Copyright:
Aerosmith Fastening Systems
5621 Dividend Road,
Indianapolis, IN 46241
United States

Passing on and duplication of this document, exploitation and disclosure of its contents are forbidden unless expressly approved. Violations render the offender liable to damages. All rights reserved for the event of patent, utility model or registered design applications.

This operating manual has been drawn up with the greatest care. Nevertheless, Aerosmith Fastening Systems assumes no liability for possible errors in this operating manual and their consequences. Furthermore, no liability is assumed for direct or consequential damages resulting from the improper use of the tool.

The national safety and occupational safety regulations and the safety precautions given in this operating manual must be observed when using the tool. All product designations and brand names are the property of their owners and are not explicitly marked as such.

Amendments to content reserved.

4 - DISPOSAL



Separate collection. Local regulations may provide for separate collection of electrical products from the household, at municipal waste sites or by the retailer when you purchase the new product.



Separate collection of packaging and failed rechargeable battery in accordance with the recycling regulations applicable in your country.

5621 Dividend
Road,
Indianapolis,
IN 46241
United States



Tel: 800.528.8183
Web: <http://www.aerosmithfastening.com/>