

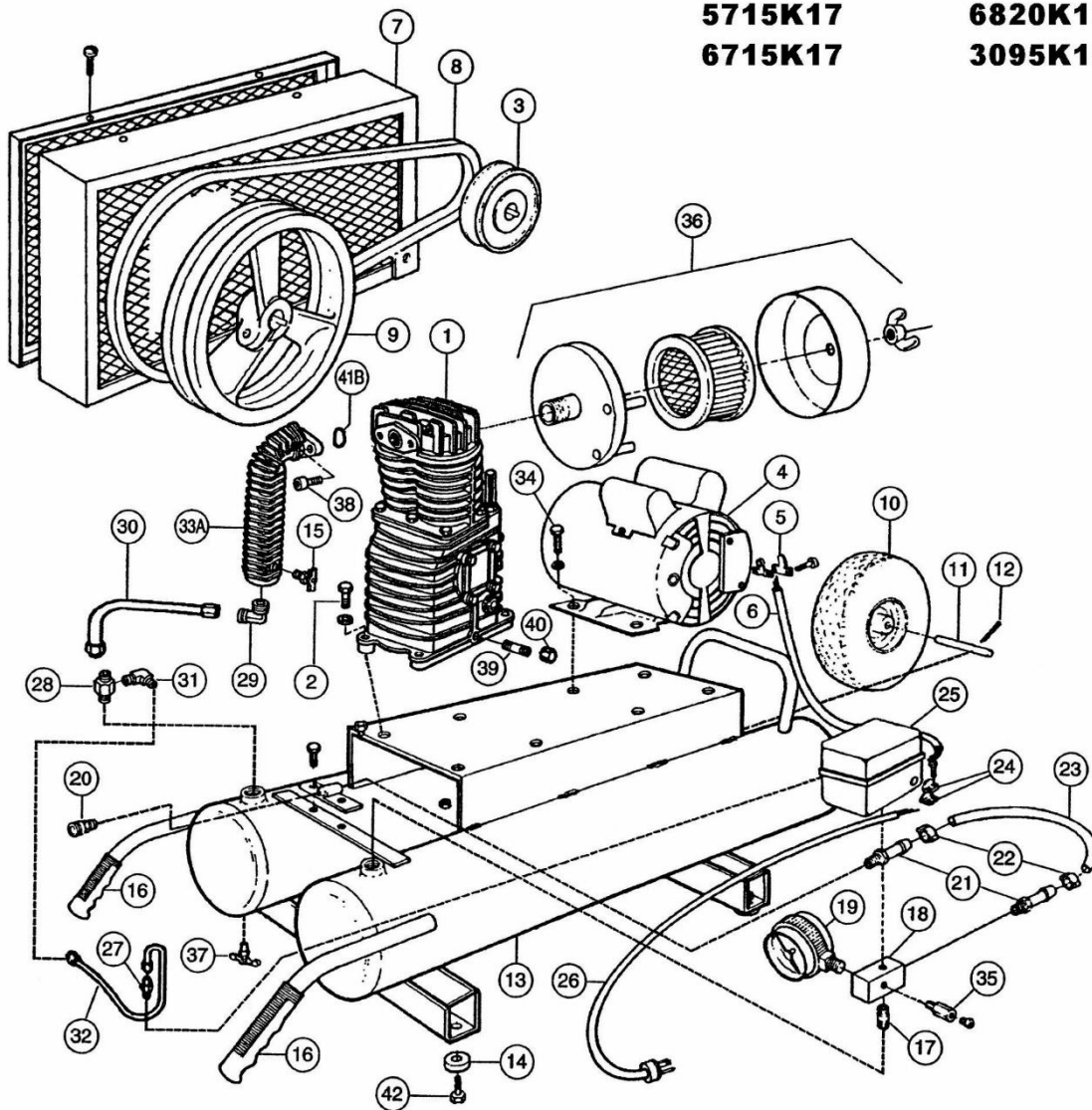

ROLAIR®

SCHEMATIC FOR MODELS
5715K17 6820K17D
6715K17 3095K18



OPTIONAL ACCESSORIES

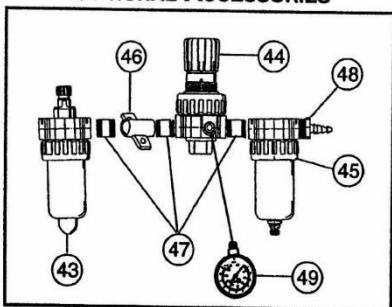

Production Prior to Feb. 2000

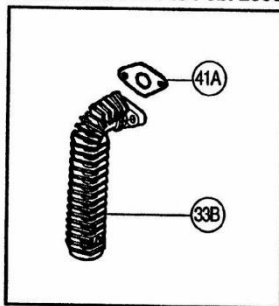

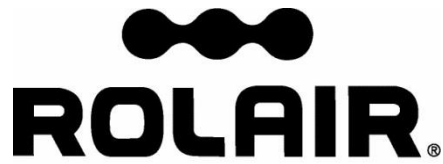

S Y S T E M S

PARTS LIST FOR MODELS
5715K17 6820K17D
6715K17 3095K18

Schem #	Description	Part #	Qty.	Schem #	Description	Part #	Qty.	
1	Twin Cylinder Pump With Flywheel	PMP12K17CH	1	26	Cord w/110V Plug - Models 5715K17, 6715K17 & 6820K17	170	1	
	Twin Cylinder Pump With Flywheel – Model 3095K18 Only	PMP12K18CH	1		Cord with 220V Plug - Model 3095K18	175	1	
2	Bolt	MIS10023	4	27	Pressure Switch Relief Valve	PS2020RV	1	
3	Motor Pulley	Specify Model	1		Pressure Switch Relief Valve – Model 3095K18 Only	PS4040RV	1	
4	1.5 HP Motor – Models 5715K17 & 6715K17	MTRC101	1	28	Check Valve (Before S/N 15080001)	N.L.A.		
	1.5 HP Motor w/Dual-Voltage Switch	MTRC102	1		Check Valve (After S/N 15080001)	CV4X4T-A175	1	
	2 HP Motor – Model 6820K17	MTRD103	1	29	Brass Elbow	BREL0500X050039	1	
	3 HP Motor – Model 3095K18	MTRE101	1	30	Discharge Tube	SPECIFY MODEL	1	
5	Box Connector	161A	2	31	Brass Elbow	BREL0250X012539	1	
6	Cord	173A	1	32*	1/4" Nylon Tubing – 15.6" - Models 5715K17, 6715K17 & 6820K17	178D	1.3'	
7	Belt-Guard Base (Before S/N 11070001)	***N.L.A.			Brass Nut	BRNT0250	2	
	Belt-Guard Base (After S/N 11070001)	BG566A	1		Brass Sleeve	BRSL0250	2	
	Belt-Guard Cover (Before S/N 11070001)	***N.L.A.			Brass Ring	BRRG0250	2	
	Belt-Guard Cover (After S/N 11070001)	BG567	1		1/4" Copper Tubing – 18" - Model 3095K18	CTUBE14	1.5'	
8	Belt	Specify Model	1		Brass Nut	BRNT0250	2	
9	Flywheel	31007280CH	1		Brass Ring	BRRG0250	2	
10	Foam-Filled Flat-Free Tire	WLS50	1		33A	Aftercooler	3290146ACH	1
11	Axle	181	1		33B	Aftercooler	USE 3290146ACH	1
12	Cotter Pin	181A	2		34	Bolt	MIS10022	6
13	Twin Tank Assembly	Specify Model	1	35	Safety Relief Valve	SRV0250A165	1	
14	Rubber Foot	219	4	36	Silencer/Filter Assembly	FS14050	1	
15	Drain Valve	132	1		Filter Element – Replacement for Above	431	1	
16	Handle Grip	328	2	37	Drain Valve	132BV	2	
17	Nipple	BLNP0500X1500	1	38	Bolt	37302530CH	2	
18	Aluminum Block Manifold**	154	1	39	Nipple	BLNP0250X1500	1	
19	Gauge – Tank	GA0250200GC	1	40	Cap	BLCA0250	1	
20	Quick Disconnect (Optional)	309A	1	41A	Gasket	30501490CH	1	
21	Brass Coupler	BRCP0375X0375H12	2	41B	O-Ring	30502510CH	1	
22	Hose Clamp	177A	2	42	Screw	MIS10008	4	
23	3/8" Rubber Hose – 16"	178A	1.34'	(Accessories)				
24	Box Connector	161	1	43	Lubricator	LUB0375	1	
25	Pressure Switch	PS2020M	1	44	Regulator	REG0375	1	
	Pressure Switch – Model 3095K18 Only	PS4040	1	45	Filter	FIL0375	1	
				46	Accessory Bracket	210	1	
				47	Nipple	BLNP0375X1500	3	
				48	Brass Coupler	BRCP0375X0375H12	1	
				49	Gauge - Line	GA0250200GC	1	

*Note: Nylon & Copper Tubing are sold by the foot; may be ordered in bulk lengths.

**Order part #154D if unit is built with dual controls.

***Units built prior to July 2011, order complete belt guard; part numbers BG566A and BG567.

As an additional safety measure, twin-tank electric models built after August 1, 2015 include additional safety valve on check valve.

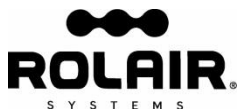

606 South Lake Street > P.O. Box 346 > Hustisford, WI 53034-0346 > 920.349.3281 > fax 920.349.8861 > www.rolair.com

ROLAIR[®]
 SCHEMATIC FOR
 PMP12K17

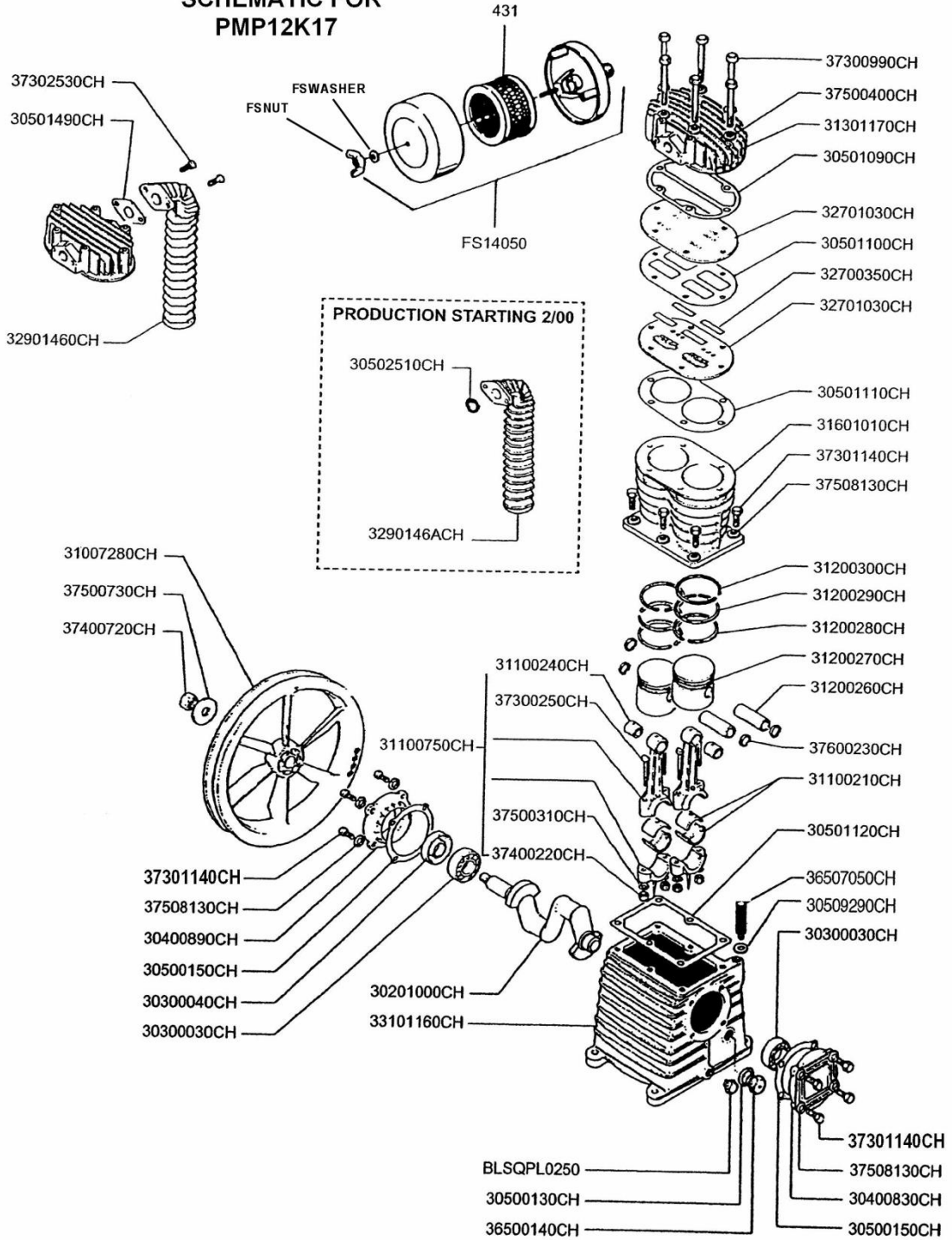

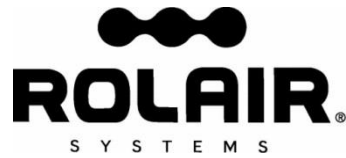

PARTS LIST FOR PMP12K17

Description	Part #	Qty.
Crankshaft	30201000CH	1
Bearing	30300030CH	2
Oil Seal	30300040CH	1
Bearing Carrier	30400830CH	1
Bearing Carrier	30400890CH	1
Gasket	30500130CH	1
Gasket	30500150CH	2
Gasket	30501090CH	1
Gasket	30501100CH	1
Gasket	30501110CH	1
Gasket	30501120CH	1
Gasket	30501490CH	1
O-Ring	30509290CH	1
Flywheel	31007280CH	1
Bearing Shell	31100210CH	2
Bushing*	31100240CH	2
Connecting Rod with Upper Bushing	31100750CH	2
Connecting Rod Assembly	31100750CH1	2
Piston Pin	31200260CH	2
Piston	31200270CH	2
Ring	31200280CH	2
Ring	31200290CH	2
Ring	31200300CH	2
Head	31301170CH	1
Cylinder	31601010CH	1
Valve	32700350CH	4
Valve Plate	32701030CH	2
Aftercooler	32901460CH	1
Crankcase	33101160CH	1
Sight Gauge	36500140CH	1
3/8" Breather/Oil Fill Plug	36507050CH	1
Bolt	37300250CH	4
Bolt	37300990CH	6
Bolt	37301140CH	14
Bolt	37302530CH	2
Nut	37400220CH	4
Nut	37400720CH	1
Washer	37500310CH	4
Washer	37500400CH	6
Washer	37500730CH	1
Washer	37508130CH	14
Snap Ring	37600230CH	4
Filter Element	431	1
Plug	BLSQPL0250	1
Silencer/Filter Assembly	FS14050	1
Nut	FSNUT	1
Washer	FSWASHER	1
Ring Set	K17RINGS	1
Gasket Set	K17GASKETS	1
Valve Plate Assembly (Valve plates, reeds & upper three gaskets)	1700VK17	1
Piston Assembly (Piston, rings, piston pin & snap rings)	1700PK17	2
Valve Kit (Reed Valves & Upper 3 Gaskets)	VKK17	1
AFTERCOOLER PARTS STARTING 2/00		
O-Ring – Aftercooler	30502510CH	1
Aftercooler	3290146ACH	1

*Bushing is not machined to fit piston pin if ordered separate from connecting rod.

