



*Separately Download Enforcer SK-2323-SPQ Keypad Manual

HD ANALOG SERIES USER MANUAL

MODELS COVERED:

- | | | | |
|-------------------|----------------------|----------------------|----------------|
| RQX-127-HD | RQX-127-HD-KP | RQX-127M-HD | RQX-127M-HD-KP |
| RQX-127M-HD-CC | RQX-127M-HD-GG | RQX-127M-HD-GG-KP | RQX-427-HD |
| RQX-427-HD-CC | RQX-427-HD-GG | RQX-427-HD-GG-KP | RQX-427-HD-KP |
| RQX-127-HD-CANADA | RQX-127-HD-CANADA-KP | RQX-127-HD-CANADA-GG | |
| RQX-427-HD-CANADA | RQX-427-HD-CANADA-KP | RQX-427-HD-CANADA-GG | |



Ritron Pub. 14500109

Rev. A

2/25

© 2025 Ritron, Inc. All rights reserved. Ritron, Patriot, Jobcom, OutPost, GateGuard, Quiet Call and Quick Assist are registered trademarks of Ritron, Inc. Quick Talk, Liberty and RadioNexus are trademarks of Ritron, Inc.

Call 800-872-1872

For the right Wireless Solutions for your communication needs.

P.O. Box 1998 • Carmel, Indiana 46082-1998 • Ph: 317-846-1201

Email: ritron@ritron.com • www.ritron.com

TABLE OF CONTENTS

Basic Operation

HD-SERIES CALLBOX MODELS.....	1
ABOUT THE HD-SERIES CALLBOX	2
EXPOSURE TO RADIO FREQUENCY ENERGY	3
OPERATING THE HD-SERIES CALLBOX WITH FACTORY DEFAULT SETTINGS.....	3

Installation Instructions

APPLYING POWER TO THE HD-SERIES CALLBOX.....	4
Using Internal Batteries.....	4
Using External +12 VDC Power with Battery Back-up.....	5
Using External +12 VDC Power without Battery Back-up.....	5
POWER MANAGEMENT OPTIONS	6
FIG-1: Sensor Turn-On Jumper Shown in <u>Turn-On</u> Position.....	6
RELAY POLARITY JUMPER SETTING.....	6
ANTENNA JUMPER SETTING	7
CALLBOX CONTROLS AND CONNECTORS	8
FIG-2: Callbox Controls and Connectors.....	8
CONNECTING TO THE HD ACCESSORY CABLE.....	9
Drilling Instructions.....	9
Instructions for Wiring to the HD Accessory Cable.....	10
R-STROBE-DC INSTALLATION FOR THE HD-SERIES CALLBOX....	11
HD-SERIES CALLBOX INSTALLATION INSTRUCTIONS.....	12

Field Programming

HD-SERIES FIELD PROGRAMMING OVERVIEW.....	13
HOW TO FIELD PROGRAM FREQUENCY & TONE CODES.....	14
TABLE 1: PROGRAMMABLE FREQUENCY CODES.....	15
CANADIAN FREQUENCY CODES	16
TABLE 2: PROGRAMMABLE QC TONE CODES.....	16
TABLE 3: PROGRAMMABLE DQC TONE CODES	16
HOW TO FIELD PROGRAM 2-TONE, DTMF OR SELCALL DECODE (RECEIVE) OPERATION	17
TABLE 4: PAGING, GATEGUARD® AND LISTEN IN DECODE CODES.....	19
HOW TO FIELD PROGRAM DTMF OR SELCALL ENCODE ANI (TRANSMIT) CODES	21
HOW TO FIELD PROGRAM FEATURE CODES.....	22
TABLE 5: ADVANCED FEATURE CODES	23

Programmable Features

PC PROGRAMMABLE HD-SERIES CALLBOX FEATURES	25
Glossary of Terms.....	25
TABLE 6: PC PROGRAMMABLE FEATURES	25
INTERCOM (ALWAYS-ON) PROGRAMMING.....	27
FEATURES TO USE WITH INTERCOM (ALWAYS-ON) PROGRAMMING	27
RELAY SWITCH OUTPUT OPTIONS (ALLOWS CONTROL OF AN EXTERNAL DEVICE)	28
2-TONE, DTMF OR SELCALL DECODE (RECEIVE) SETTINGS.....	29

Voice Messages

AUTOMATIC VOICE MESSAGES.....	30
AUTOMATIC ID RE-SEND	31
HOW TO RECORD A VOICE MESSAGE	32
HOW TO RECORD A VOICE MESSAGE USING .WAV AUDIO FILES ..	33
HOW TO PLAY A VOICE MESSAGE	34
HOW TO ERASE A VOICE MESSAGE.....	34

GateGuard® Application

<i>Configuration for the Remote Control of a Gate Controller</i>	
CONFIGURING THE CALLBOX FOR A GATEGUARD® APPLICATION..	35
TABLE 7: HD ACCESSORY CABLE.....	35
HOW TO FIELD PROGRAM THE HD-SERIES CALLBOX FOR GATEGUARD® OPERATION.....	36
OPTIONAL GATEGUARD® SETTING/FEATURES	36

Licensing

FCC Licensing.....	38
How to Obtain an FCC Radio License	38
INDUSTRY CANADA Regulations.....	38
Safety Standards	38
Service	38

Warranty

RITRON, INC. LIMITED WARRANTY	39
-------------------------------------	----

THANK YOU FOR CHOOSING RITRON

Congratulations on your purchase of the RQX HD-Series Callbox. Your new radio is the culmination of RITRON's 45 years of designing, manufacturing, and supplying reliable, professional wireless communication products. Ritron wireless products will improve the operation, safety, and profitability of any organization by providing instant voice communications between employees throughout the workplace.

HD-SERIES CALLBOX MODELS

HD-Series USA Models

- RQX-127-HD VHF Vandal-Resistant HD Callbox
- RQX-127-HD-KP VHF Vandal-Resistant HD Callbox with Keypad
- RQX-127M-HD MURS Vandal-Resistant HD Callbox
- RQX-127M-HD-CC MURS Vandal-Resistant HD Callbox – Club Call
- RQX-127M-HD-GG MURS Vandal-Resistant HD Callbox - GateGuard
- RQX-127M-HD-GG-KP MURS Vandal-Resistant HD Callbox – GateGuard with Keypad
- RQX-127M-HD-KP MURS Vandal-Resistant HD Callbox with Keypad
- RQX-427-HD UHF Vandal-Resistant HD Callbox
- RQX-427-HD-CC UHF Vandal-Resistant HD Callbox – Club Call
- RQX-427-HD-GG UHF Vandal-Resistant HD Callbox – GateGuard
- RQX-427-HD-GG-KP UHF Vandal-Resistant HD Callbox – GateGuard with Keypad
- RQX-427-HD-KP UHF Vandal-Resistant HD Callbox with Keypad

HD-Series Canada Models

- RQX-127-HD-CANADA VHF Canadian model Vandal-Resistant HD Callbox
- RQX-427-HD-CANADA UHF Canadian model Vandal-Resistant HD Callbox

The HD-Series callbox is available in a Vandal-Resistant, High-Visibility Green.

The model number appears on the serial label located on the bottom of the enclosure.

VHF radios are designed to operate within the 15 MHz band between factory standard 150 and 165 MHz at 2W transmit power.

UHF radios are designed to operate within the 20 MHz band between factory standard 450 and 470 MHz at 1.5W transmit power.

MURS radios can only operate on the 5 MURS frequencies (151.820, 151.880, 151.940, 154.570, or 154.600 MHz) at 2W transmit power.

Advanced Features available with the HD-Series models include 2-Tone, DTMF and Selcall Decode, Voice Messages, Companding, Sensor Input, and a Relay Switch Closure.

OPTIONAL ACCESSORY EQUIPMENT

Several options are available for the Ritron HD-Series Callbox. These options, individually, or in combination with one another can greatly enhance the functionality of the callbox as well as the overall communication system. Available options include:

- **RQX-HDMK** – The RQX-HDMK is a mounting bracket used to mount the HD callbox to most flat surfaces or to an industry standard gooseneck post.
- **Entry Keypad** – RQX-127-HD-KP and RQX-427-HD-KP “keypad versions” of the HD-Series callbox are available to allow local access with up to 500 unique codes. This version hosts a 2x6 DTMF keypad mechanically mounted to the stainless steel faceplate.
- **RPS-EXPO** – 12VDC power supply used to externally power the HD-Series callbox.
- **RSS-100** - The RSS-100 is a complete solar power supply system consisting of a 10-watt solar panel, charge controller and 8 AH rechargeable battery all housed in a rugged, ready-to-mount enclosure.
- **R-STROBE-DC** - The R-STROBE-DC is a powerful strobe light, giving a visual indication of a callbox in use.
- **RCIM-1200** - The RCIM-1200 MDC-1200 encoder board allows each callbox to be assigned a unique unit ID number.

For additional information and pictures of these items go to:

<https://www.ritron.com/HD-series-heavy-duty-model-7-callbox-analog> and download pdf of the product brochure.

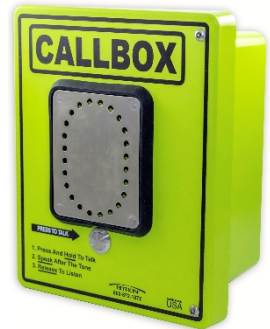

HD-Series Callbox

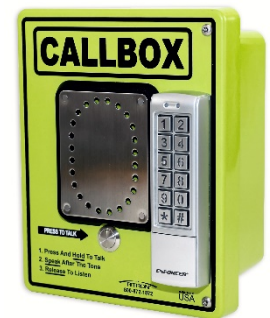

HD-Series Callbox with Keypad



HD-Series Callbox with optional RQX-HDMK mounting bracket



RPS-EXPO

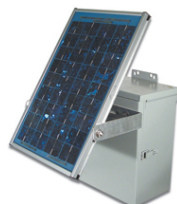

RSS-100



R-STROBE-DC



RCIM-1200

ABOUT THE HD-SERIES CALLBOX

The HD-Series Callbox is a 2-way radio transceiver used to communicate directly with portable, mobile and stationary radios; or through radio repeaters with Ritron PC Programming software. Each callbox is equipped with the following features or capabilities.

- **Field Programming.** Field programming allows you to quickly program your radio in the field without the need for a PC programmer. Each radio can be field programmed to one of 27 VHF, 114 UHF, or 7 MURS channel table frequencies, and one of 50 QC or 104 DQC interference eliminator codes.
- **MURS “License Free” Frequencies.** MURS models can be programmed from a list of 7 MURS frequencies that do not require FCC licensing.
- **154 Interference Eliminator Codes.** Quiet Call (QC) and Digital Quiet Call (DQC) codes can be programmed to eliminate other radio users not in your workgroup. For compatibility, new radios should be programmed with the same codes.
- **Volume Level.** Field programmable or PC programmable to 5 – 100% volume level.
- **Normal or High Microphone Gain.** Field and PC programmable to normal or high microphone gain.
- **Battery Powered.** The HD-Series Callbox can be powered by 6 Alkaline D-cell batteries for 2 Watts transmit power at VHF, or 1.5 Watts at UHF. D-cell batteries can operate the radio for up to 7,000 transmissions. Go to <https://www.ritron.com/tools> and download the RQX CALLBOX BATTERY LIFE CALCULATOR to compute the expected battery life of your callbox application. When the callbox is used in a battery only application, the Auto Turn-Off feature should be enabled – this is the Factory Default setting.
- **Low Battery Alert.** The callbox will transmit an Alert Tone or pre-recorded Low Battery voice message at the end of each transmission when the batteries approach end-of-life. This allows sufficient time for you to replace the batteries and assure uninterrupted service.
- **External Power +12 VDC Capable.** The HD-Series Callbox can be powered by an external +12 VDC source. This method of powering the callbox allows the radio to remain **ON** at all times, like an intercom. Automatic Turn Off must be **DISABLED** via Field or PC programming for Intercom operation.
- **+12 VDC Power Fail Alert.** This feature can be enabled via Field or PC programming. The callbox will transmit an Alert Tone or pre-recorded Power Fail voice message if it detects loss of +12 VDC power. The radio automatically continues to transmit an Alert Tone once every hour (unless programmed for Automatic Turn Off) until +12 VDC is restored or the batteries are depleted.
- **High/Low Power Output.** When powered by External +12VDC the HD-Series callboxes can be Field programmed for High or Low transmitter power output.
- **“Automatic Turn-Off” or “Intercom” Operation.** The HD-Series Callbox can operate in the standard “Automatic Turn-Off” mode (Factory Default), where the radio is normally **OFF** until the Call Button is pressed, or can be Field or PC programmed for “Intercom” operation where the radio is always **ON**. See “External Power +12 VDC Capable” feature above.
- **DTMF or Selcall ANI.** Field or PC Programmable for 3-7 digit DTMF or Selcall ANI codes which are transmitted at the beginning of each message for radio identification.
- **Listen In.** Allows remote activation of the transmitter when a unique 2-Tone, DTMF or Selcall code is received. Field or PC programmable to 2-Tone, DTMF or Selcall codes and 4 different Listen In transmit times.
- **2-Tone, Selcall or DTMF Decoding.** The Callbox can be programmed to decode unique 2-Tone, Selcall or DTMF codes for selective signaling of the Callbox, “Listen In” remote activation of the transmitter.
- **Voice Messages.** You can record custom voice messages that are played back during normal Callbox operation. Messages include Greeting, Voice Alert, Sensor status, Battery status, and +12VDC Power Fail.
- **Sensor Turn-On.** When operating the Callbox with Automatic Turn-Off enabled, the unit can be configured to turn itself **ON** any time the Sensor Input is pulled **LOW** (ground). This allows an external switch closure to activate the Callbox.
- **2-Tone, Selcall or DTMF Decoding for Switch Operation.** The Callbox can be programmed to decode unique 2-Tone, Selcall or DTMF codes for switch output activation in GateGuard® applications.
- **Relay Switch Output.** The switch output is a simple 3-Amp relay contact closure that can be used to **OPEN** and **CLOSE** a gate, switch on a light, sound an alarm or any other application where remote control of an ON/OFF switch is required. The HD-Series Callbox can be programmed to **OPEN** and **CLOSE** the switch output with a 2-Tone, Selcall, or DTMF code.
- **Sensor Input.** The Callbox will send a warning tone or a pre-recorded voice message when a change in the Sensor Input is detected. The Sensor Input will respond to an **OPEN** or **CLOSED** switch.

EXPOSURE TO RADIO FREQUENCY ENERGY

RQX-127-HD, RQX-127-HD-CANADA, RQX-127-HD-CANADA-KP, RQX-127-HD-KP, RQX-127M-HD, RQX-127M-HD-CC, RQX-127M-HD-GG, RQX-127M-HD-GG-KP, RQX-127M-HD-KP

RQX-427-HD, RQX-427-HD-CANADA, RQX-427-HD-CANADA-KP, RQX-427-HD-CC, RQX-427-HD-GG, RQX-427-HD-GG-KP, RQX-427-HD-KP

These products generate radio frequency (RF) energy when the PTT button on the front of the unit is depressed. These products have been evaluated for compliance with the maximum permissible exposure limits for RF energy at the maximum power rating of the unit when using antennas available from RITRON.

For antennas available from RITRON at the 20 cm (7.9 inches) minimum expected separation distance and greater, the maximum RF exposure is well below the General Population / Uncontrolled limits. Antennas other than those available from RITRON have not been tested for compliance and may or may not meet the exposure limits at the distances given. Higher gain antennas are capable of generating higher fields in the strongest part of their field and would, therefore, require a greater separation from the antenna. This product is not to be used by the general public in an uncontrolled environment unless compliance with the Uncontrolled/General Population limits for RF exposure can be assured.

To limit exposure to RF energy to levels below the limit, please observe the following:

- Use only the antenna(s) available from RITRON for these models. DO NOT operate the radio without an antenna.
- DO NOT activate the transmitter when not actually wishing to transmit. These radios transmit recorded messages of a pre-determined length to prevent continuous transmit times.
- When transmitting, make certain that the distance limits for the particular model in use are observed.
- DO NOT allow children to operate the radio.

When used as directed, this series of radios is designed to comply with the FCC’s RF exposure limits for “Uncontrolled/General Population”. In addition, they are designed to comply with the following Standards and Guidelines:

- United States Federal Communications Commission, Code of Federal Regulations; 47 CFR §§ 2 sub-part J.
- American National Standards Institute (ANSI) / Institute of Electrical and Electronic Engineers (IEEE) C95. 1-1992.
- Institute of Electrical and Electronic Engineers (IEEE) C95.1-1999 Edition.
Copyright Telecommunications Industry Association

OPERATING THE HD-SERIES CALLBOX WITH FACTORY DEFAULT SETTINGS.....

The HD-Series Callbox Factory Default setting is with Automatic Turn-Off **ENABLED**. This means the callbox is **OFF** and will not receive a call until the callbox first initiates a call. When the callbox is used in a battery only application, the Auto Turn-Off feature should be Enabled.

In Automatic Turn Off mode the callbox automatically shuts off after ten (10) seconds of no activity (i.e. transmitting or receiving) on the channel.

To Initiate a Call

Press and hold the **ON/PTT** Button. The callbox will send a unique **CALL TONE** to alert radio equipped personnel. This **CALL TONE** will also be heard at the callbox. Listen for the “beep”, then, begin speaking into the MIC. For best communication, the caller should be 3 feet or less from the microphone.

To Receive a Call

1. When you have finished speaking, release the **ON/PTT** Button.
2. Any reply will be heard through the callbox speaker. If a call is not received within 10 seconds of releasing the **ON/PTT** Button and there is no activity on the channel, the callbox will sound a low double tone and turn-off automatically. This automatic turn-off feature is designed to conserve battery life.

Operation Notes

The HD-Series Callbox must be powered with Alkaline batteries **ONLY**, or alternatively, with an external 12 VDC power supply, order Ritron model **RPS-EXPO** 110 VAC to 12 VDC cube power supply. When using an external 12 VDC supply, the Alkaline batteries can be used as back-up. See Using External +12 VDC Power with Battery Back-up on page 5 for details.

If there has been no activity for 10 seconds, i.e. either the **ON/PTT** Button has not been pressed or a call has not been received, the unit automatically shuts **OFF**.

Low Battery Alert

The callbox will transmit an Alert Tone at the end of each transmission when the batteries approach end-of-life. This allows sufficient time for you to replace the batteries and assure uninterrupted service. On HD-Series Callboxes the LOW battery alert tone can be replaced by a LOW battery voice message.

APPLYING POWER TO THE HD-SERIES CALLBOX

The HD-Series Callbox may be powered by:

1. 6 D-cell batteries for 2W operation.
 - Powering the callbox from internal alkaline batteries will allow for an installation that does not require wiring to an external source of power.
 - When the callbox is used in a battery only application, the Auto Turn-Off feature should be Enabled – this is the Factory Default setting, battery only operation is not suitable for Always-On mode.
2. An external +12 VDC source (Use Ritron pn RPS-EXPO) for 2W operation.
 - Powering the callbox by an external source will allow the unit to remain in Always-ON mode, like an intercom*. Be advised that battery only operation is not suitable for Always-On mode.

To extend battery life, one of two battery saver options may also be used. See POWER MANAGEMENT OPTIONS on page 6.

* Automatic Turn Off must be **DISABLED** via Field or PC Programming.

Using Internal Batteries

Batteries may be installed in the internal battery holder for a no trenching, no wires required installation. If internal batteries are used, a LOW battery alert tone will be transmitted when the battery voltage drops below a programmed value. The LOW battery tone notifies personnel that the batteries should be replaced. On HD-Series Callboxes the LOW battery alert tone can be replaced by a LOW battery voice message.

IMPORTANT! When installing D-cell batteries be sure all are the same new cells. DO NOT mix new and used batteries.

HD-Series Battery Installation

1. Using the T-25 Torx bit included with the radio, loosen the two captured screws on the front the hinged HD case and open.
2. Disconnect the power cable connecting the battery holder to the radio and loosen the two black Velcro straps used to secure the batteries.
3. Install 6 new **new** D-cell batteries into the battery holder. Be sure to observe polarity as indicated. **Warning!** Do not mix old and new batteries.
4. Tighten the two black Velcro straps around the batteries and re-connect the power cable.
5. Close the case front and tighten the two captured case screws.

IMPORTANT! Be sure the battery power cable or HD Accessory Cable are not trapped between the case front and case back. This will compromise the water seal.

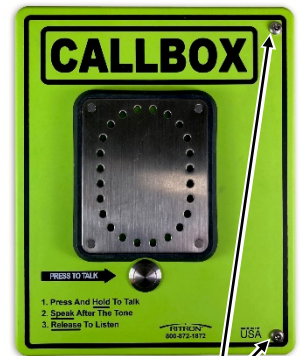

Captured Case Screws

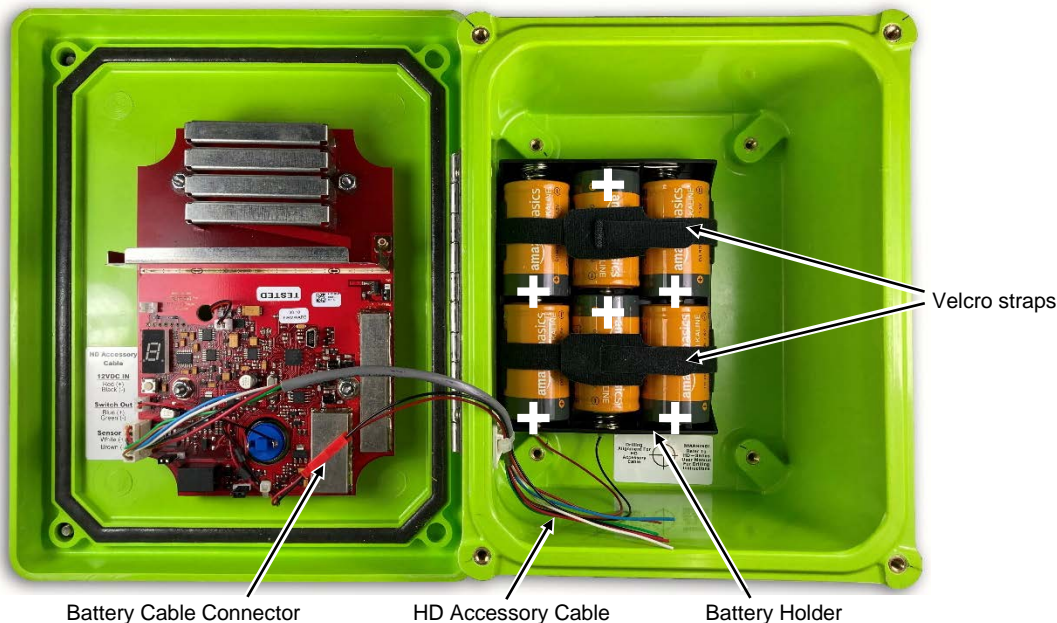

Using External +12 VDC Power with Battery Back-up

Note: An additional hole, strain relief, or conduit will need to be installed into the callbox. See [CONNECTING TO THE HD ACCESSORY CABLE](#) section on page 9 for details.

The unit may be powered by an external source of +12 VDC. This source should be filtered, with minimum noise and hum, and capable of supplying at least 1 Ampere.

Factory Default programming of the callbox is optimized for battery power operation. The External +12 VDC Power Fail Alert option is **NOT ENABLED**.

If an external source of power is used, internal batteries can be installed as a back-up against loss of power. If this option is chosen, we recommend that the “External +12 VDC Power Fail Alert” feature be **ENABLED** via Field or PC programming.

How the Callbox will Operate:

If External +12 VDC Power Fail Alert Feature is NOT ENABLED:

- LOW battery detection can only occur when the +12 VDC is removed or failed.
- Radio will only check for LOW battery or DEAD battery condition when the radio is **ON**.
- If LOW battery is detected, a single Alert Tone will be transmitted at the end of the transmission.
- Radio does **NOT** automatically transmit a LOW battery tone. The callbox must be **ON** and the Alert Tone is only sent at the end of a transmission.
- If DEAD battery is detected, the radio ceases all operation. A DEAD battery tone is heard on the callbox speaker and the radio will turn **OFF**.
- On HD-Series Callboxes the LOW battery alert tone can be replaced by a LOW battery voice message.

If External +12 VDC Power Fail Alert Feature is ENABLED:

- Radio always checks for External +12 VDC when the radio is **ON**. If loss of External +12 VDC is detected while the radio is in standby: *a single Alert Tone will be transmitted immediately.*
- If loss of External +12 VDC is detected while the radio is in receive: *a single Alert Tone will be transmitted after the received message is complete.*
- If loss of External +12 VDC is detected while the radio is in transmit: *a single Alert Tone will be transmitted at the end of the transmission.*
- Once loss of External +12 VDC is detected and the Alert Tone is transmitted, the radio will automatically send the Alert Tone once every hour until External +12 VDC is restored or the batteries are exhausted. If radio is set for Automatic Turn-Off (default setting) this hourly alert will **NOT** occur.
- If Dead battery is detected the radio ceases all operation, a DEAD battery tone is heard on the callbox speaker and the radio will turn **OFF**.
- On HD-Series Callboxes the loss of External +12 VDC alert tone can be replaced by a Power Fail voice message.

Using External +12 VDC Power without Battery Back-up

The Ritron RQX callbox can be programmed for always-on operation by disabling the Automatic Turn-Off option. This is accomplished using the RQX PC Programmer, or through Field Programming. Once Automatic Turn-Off is disabled, the user simply turns on the RQX by pressing the front panel PTT button and it will remain on as long as power is applied. If power to the callbox is lost, the user must press the front panel PTT to restart the radio. For externally powered callboxes, battery backup is one method of keeping the radio on if the primary external power is lost.

For users that do not want to rely on battery backup, and do not want to “restart” the callbox after a power loss, a radio modification can be made to automatically restart/Turn ON the radio after a power loss.

For details or questions about this modification contact Ritron at 1-800-872-1872 and reference Ritron publication 14670034C, RQX Q-Series Modification for Auto-Restart/Turn ON When Power Is Restored.

Important considerations before applying this modification:

- The Automatic Turn-Off option must be disabled.
- When Automatic Turn-Off is disabled the unit will consume the largest amount of current, but is always ready to instantly receive messages. This mode should only be considered if an external source of +12 VDC is available.
- The callbox receiver will always be on. All radio communication on the programmed frequency and tone will be heard over the RQX callbox.



POWER MANAGEMENT OPTIONS

There are four power management options available to the HD-Series Callbox:

Automatic Turn-Off (In battery only application Auto Turn-Off must be Enabled).....(Field or PC Programmable)

If Enabled (factory default), the callbox will automatically turn itself off after a programmed period of no activity (**no transmissions made and no calls received**) has elapsed. Once the unit has turned itself off, it can only be turned back on by depressing the **ON/PTT** Button. The programmed period of no activity necessary before the unit turns itself off is called the **RQX Reset Time**. RQX Reset Time and Automatic Turn-Off can both be Field programmed, or PC programmed by the factory or your Ritron dealer via the Ritron RQX Series PC Programmer. Automatic Turn-Off mode is the factory default mode for power management with an RQX Reset Time of 10 seconds. Battery only operation is not suitable for Always-On mode.

Battery Saver(PC Programmable Only)

This mode is similar to the Automatic Turn-Off mode except that the unit does **NOT** turn itself off after the RQX Reset Time has elapsed. Instead it reverts to a mode where the unit goes to sleep and periodically wakes up to test for receive activity on the channel. The Sleep Period (called Battery Saver Sleep Time) can be set using the Ritron RQX Series PC Programmer to between 0.5 and 8 seconds. Longer sleep times result in better battery life, but increase the chances that activity on the channel may be missed. The unit will come out of this mode when activity is detected during the wake-up period or if the **ON/PTT** button is pressed. The Automatic Turn-Off and Battery Saver modes cannot be used together. Battery only operation not suitable for Always-On mode.

Neither “Automatic Turn-Off” nor “Battery Saver” Used.....(Field or PC Programmable)

If neither Automatic Turn-Off nor Battery Saver are used the unit will consume the largest amount of current, but is always ready to instantly receive messages. This mode should only be considered if an external source of +12 VDC is available (see Using External +12 VDC Power with Battery Back-up on page 5).

Sensor Turn-On(Field or PC Programmable)

When operating an HD-Series Callbox with Automatic Turn-Off enabled, the unit can be configured to turn itself **ON** any time the Sensor Input is pulled **LOW** (ground). This allows an external switch closure to activate the Callbox.

When the switch closure is detected the Callbox will turn on and automatically transmit the Sensor On alert or Sensor ON voice message. The Callbox is then in normal operating mode and will automatically turn itself off after a programmed period of no activity as described in the Automatic Turn-Off topic in this section.

For Sensor Turn-On operation the Sensor Turn-On jumper must be placed into the “Turn-On” position. Refer to FIG-1 for correct placement of the jumper. If the Sensor Input is not used the jumper placement has no effect on Callbox operation.

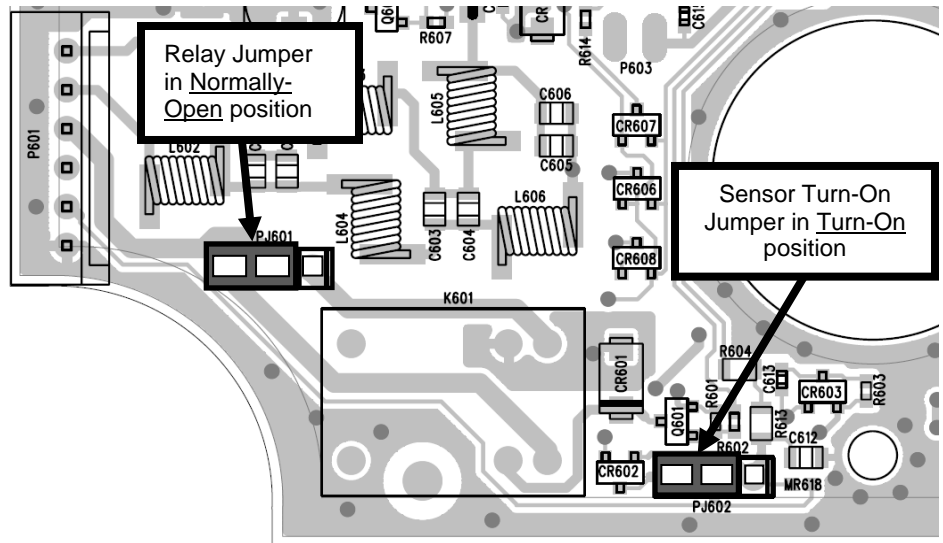

FIG-1: Sensor Turn-On Jumper Shown in Turn-On Position

RELAY POLARITY JUMPER SETTING

The HD-Series Relay Switch Output is a simple 3-Amp relay contact closure that can be used to **OPEN** and **CLOSE** a gate, switch on a light, sound an alarm or any other application where remote control of an ON/OFF switch is required. The HD-Series Callbox can be programmed to **OPEN** and **CLOSE** the switch output when a specific condition is met. Refer to the RELAY SWITCH OUTPUT OPTIONS (ALLOWS CONTROL OF AN EXTERNAL DEVICE) section on page 28 of this manual for details.

The Relay Switch Output can be set for “normally-open” or “normally-closed” operation by setting the position of the Relay Jumper as shown in FIG-1. If the Relay Switch Output is not used the jumper placement has no effect on Callbox operation.

ANTENNA JUMPER SETTING

The HD-Series Callbox is equipped with an Antenna Selector Jumper that will route all incoming and outgoing radio signals to either a built-in antenna, or to the SMB RF Test / External Antenna connector. HD-Series Callboxes have a built-in antenna and the Antenna Selector Jumper is placed in the Antenna position as it leaves the factory!

The HD-Series Callbox comes from the factory with the Antenna Selector Jumper in the "Antenna" position for operation with the built-in antenna on the callbox printed circuit board.

Important - For testing through the SMB RF connector, the Antenna Selector Jumper must be placed in the "SMB RF Test / External Antenna" position.

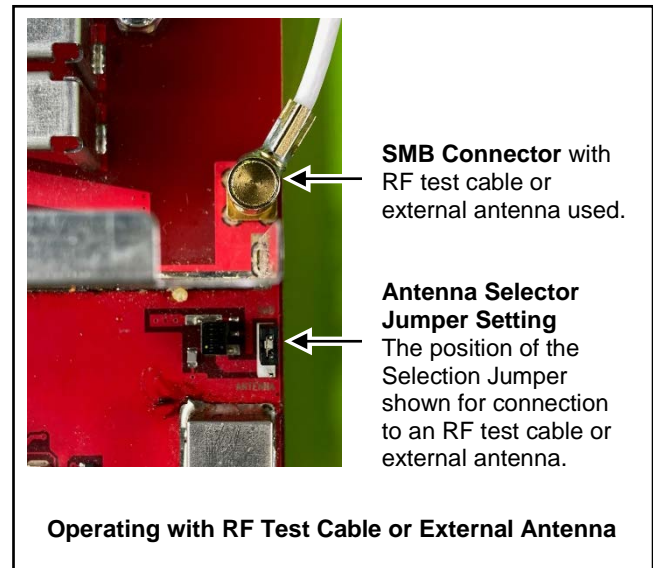
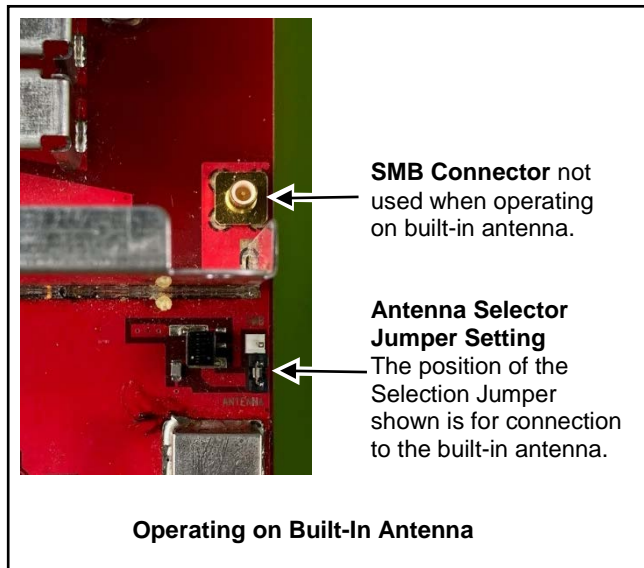

CALLBOX CONTROLS AND CONNECTORS

Antenna Jumper

The antenna jumper must be in the “Built-In Antenna” position when using the HD-Series Callbox with the Built-In Antenna. See the ANTENNA JUMPER SETTING section on page 7 of this manual for details.

SMB RF Connector

SMB style RF connector for RF testing or connection to an external antenna when the Antenna Jumper is in the “SMB RF Test / External Antenna” position.

Built-In Antenna

The HD-Series Callbox operates on a built-in antenna when the Antenna Jumper is in the “Antenna” position.

USB Programming

A Mini-USB style connector is used to connect the cable from the PC programmer to the radio.

Microphone

The microphone is installed on the PCB back side.

Speaker Connector

The internal speaker is connected to the radio printed circuit board with a polarized connector.

Record Audio Input

Allows .wav audio files from your computer to be used when recording Voice Messages.

Program Display

A single digit LED display is used during field programming of the radio.

Program Button

A small, momentary pushbutton is used for field programming the HD-Series Callbox.

On/PTT Connector

The On/PTT switch is connected to the radio printed circuit board with a polarized connector.

HD Accessory Cable Connector

The 6-pin, polarized connector is used to connect external input/output devices via the HD Accessory Cable (60101000) included with the radio. This allows connection of an external +12 VDC input, an external DC level sensor input, and a 3A contact switch closure output.

Relay Polarity Jumper

The Relay Polarity jumper can set the relay output to normally open or normally closed. (See FIG-1)

Sensor Turn-On Jumper

The Sensor Turn-On jumper can be set to turn-on the radio whenever the Sensor Input is pulled low. (See FIG-1)

D-Cell Battery Holder

The battery holder inside the case back is used for the installation of six D-cell alkaline batteries. Refer to the graphics beneath the cells for correct installation of the batteries.

Battery Mating Connectors

Polarized, 2-pin mating connectors are used to connect the batteries to the radio circuit board.

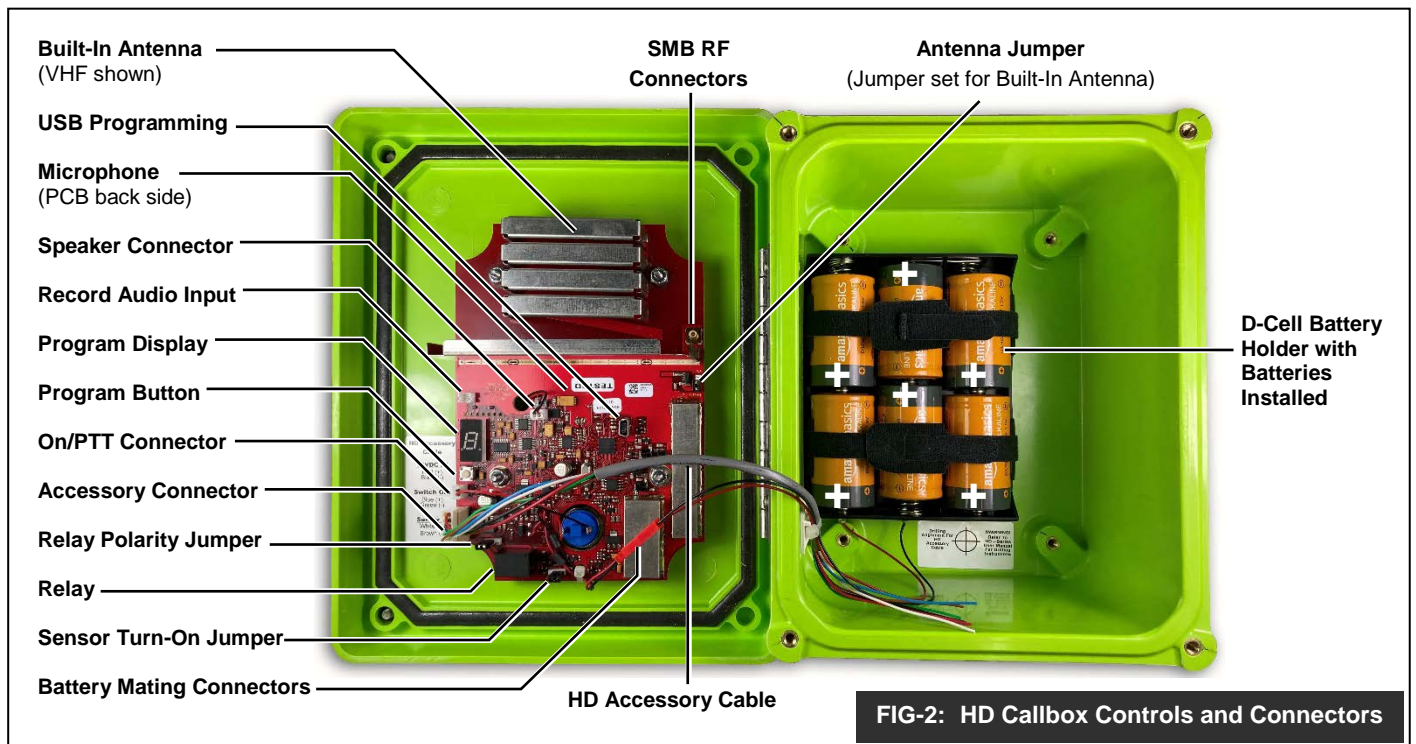

CONNECTING TO THE HD ACCESSORY CABLE

The HD Accessory Cable (PN 60101000) included with the radio allows connection of an external +12 VDC input, an external DC level sensor input, and a 3A contact switch closure output. This requires a hole drilled through the green HD case for routing a cable to the external devices used.

Drilling Instructions:

Utilizing the HD Accessory Cable requires a hole drilled through the HD-Series case. The fiberglass construction of the HD-Series case requires special consideration.

WARNING: Forcing a hole through the case will result in splintering the surface gelcoat, which could compromise the water seal ability of the Heyco® Series-35 Liquid Tight Cordgrip included with the HD Accessory Cable.

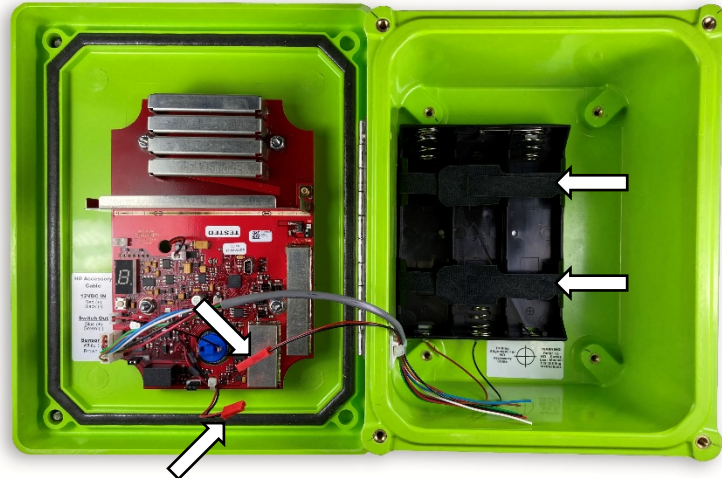

1. Using the T-25 Torx bit included with the radio, loosen the two captured screws on the front of the hinged HD case and open.
2. Disconnect the battery mating connectors.
3. Loosen the Velcro straps from around the D-cell Alkaline batteries and remove all 6 batteries from the battery holder.

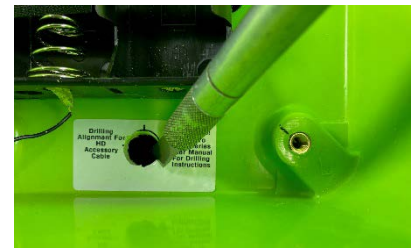
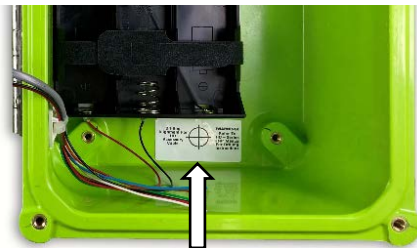

4. Locate the drilling target on the inside of the HD case.
5. Move all wires away from the drilling target.
6. Drill a 1/4" pilot hole at the center of the target from the inside of the case.
7. Drill a 1/2" hole from the inside of the case using the pilot hole as a guide. To avoid splintering, use a 1/2" drill bit to chamfer both sides of the hole before drilling the hole all the way through.
8. Remove all debris from the drilling operation.
9. Using a sharp razor knife, clear the hole and labels of all flash and debris. Leaving a flat, clean surface on both sides of the case.

Drilling alignment for HD Accessory Cable

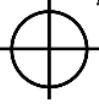

! WARNING !
Refer to HD-Series User Manual for drilling Instructions

Instructions for Wiring to the HD Accessory Cable:

the Heyco® Series-35 Liquid Tight Cordgrip included with the HD Accessory Cable will accept a sleeved, multi strand cable with an outside diameter of 0.115" to 0.25".

If your cable diameter is larger than this the Cordgrip included with the HD Accessory Cable will not work. Go to: https://www.heyco.com/Liquid_Tight_Cordgrips/product.cfm?product=Series-35-PG§ion=Liquid_Tight_Cordgrips to find a Heyco® Series-35 Liquid Tight Cordgrip suitable for your cable size.



1. Remove the bottom nut from the Heyco® Cordgrip and loosen the domed sealing nut.

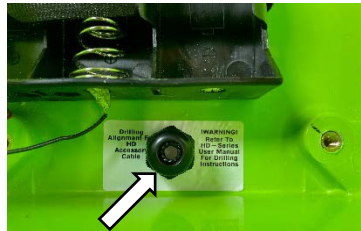

2. Insert the threaded Heyco® Cordgrip through the 1/2" hole.

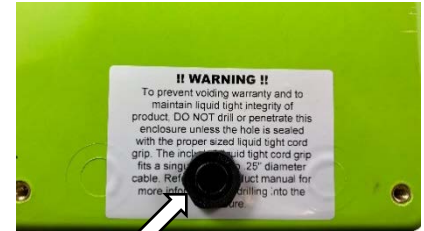

3. From the outside of the case, thread the bottom nut onto the Heyco® Cordgrip and tighten.

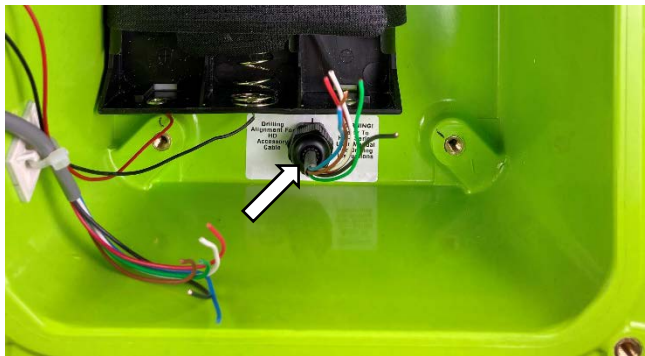

4. From outside the case, feed the sleeved, multi strand cable from your external device through the Heyco® Cordgrip. The sleeve must extend past the Cordgrip as shown. Be sure to leave enough length for connection to the HD Accessory Cable.

5. Tighten the domed sealing nut to secure the cable.



6. Strip off 1/4" of insulation from the the wires you intend to use and use wirenuts to make connections from the HD-Series Callbox to your external device.

HD Accessory Cable Wire Colors

Red	+12VDC External Power Supply
Black	External Power Supply Ground
Blue	Relay Switch Output Connection (+)
Green	Relay Switch Output Connection (-)
White	Sensor Input
Brown	Sensor Input Ground

Re-assemble the HD-Series Callbox:

7. Reconnect the battery mating connectors.
8. Re-Install the 6 D-cell Alkaline batteries into the battery holder (if used in your application) and secure with the Velcro straps.
NOTE: In +12VDC externally powered installations it is recommended that batteries are not installed unless battery backup is required.
9. Test for the desired radio operation for your installation.
10. Close the HD-Series callbox front, being careful to not pinch any of the wires between the case front and case back.
11. With a hand tool, tighten the two captured screws on the front of the HD case using the T-25 Torx bit included with the radio. Do not overtighten.

R-STROBE-DC INSTALLATION FOR THE HD-SERIES CALLBOX

The RQX HD-Series Callbox includes a built-in relay that can be used to operate a strobe light in a number of configurations. This is accomplished using the HD Accessory Cable installed in all HD-Series callboxes. Refer to the CONNECTING TO THE HD ACCESSORY CABLE section on page 9 of this manual for detailed instructions.

The HD Accessory Cable can provide:

- A normally open relay switch that closes when a programmed event occurs. The relay switch can handle up to 3A when used to connect power to a strobe light.
- A normally closed relay switch that opens when a programmed event occurs.
- Provisions for an external +12VDC input supply that can be used to power the RQX Callbox and an LED strobe light rated at 400mA or less.
- A ground connection that can be used to provide a switch closure to ground.

The Callbox must be programmed for the desired Relay operation:

- Refer to TABLE 4: PAGING, GATEGUARD® AND LISTEN IN DECODE CODES – Operation Codes for programming options and instructions.

If the strobe light is to be powered through the Callbox an external +12VDC supply is required:

- Order Ritron RPS-EXPO (PWR SUPPLY FOR CALLBOX, 110VAC/12VDC@1.5A)

HD Accessory Cable Connections:

Pin #	Wire Color	Description	
6	Red	External 12 VDC input	+ connection
5	Black	External 12 VDC input	- connection
4	Blue	Relay Switch Output	+ connection
3	Green	Relay Switch Output	- connection
2	White	Sensor Input	+ connection
1	Brown	Ground	- ground

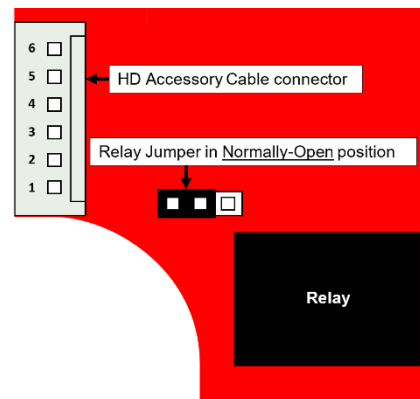

Note: The Relay Polarity Jumper is shown in the Normally-Open position (factory default). If Normally-Closed Relay operation is required, move the jumper one position to the right.

Using the relay to connect External 12VDC from the HD-Series callbox to the R-STROBE-DC

- The strobe light is activated when the relay closes.
- The Relay Polarity Jumper is in the Normally-Open position.
- The R-STROBE-DC operates on +12VDC, and requires 400mA or less.
- Short the Green and White wires together on the R-STROBE-DC for strobe operation, leave both wires unterminated for constant on operation.
 1. RQX Blue wire to R-STROBE-DC Red wire
 2. RQX Red and Green wires to RPS-EXPO (+) connection
 3. RQX Black wire to RPS-EXPO (-) connection
 4. RQX Brown wire to R-STROBE-DC Black wire

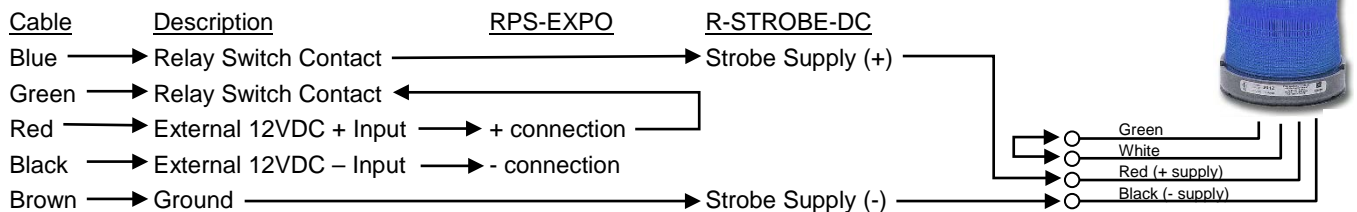

HD-SERIES CALLBOX INSTALLATION INSTRUCTIONS

Before Installing the HD-Series Callbox

1. Using the T-25 Torx bit included with the radio, loosen the two captured Torx screws on the front of the hinged HD case and open.
2. Remove the "Mounting Bracket" kit secured to the inside of the HD Callbox case.
3. Install 6 D-cell alkaline batteries into the battery holder. Refer to FIG-2, or the graphics beneath the cells, for correct installation of the batteries.
4. If required, program the radio. Refer to the programming section of this manual for details.
5. Close the HD-Series callbox front, being careful to not pinch any of the wires between the case front and case back. Tighten the two captured screws on the front of the HD case using the T-25 Torx bit included with the radio.

CAUTION Do not drill or penetrate the HD-Series Callbox case with any additional mounting holes. Use only the mounting brackets included with the product, or optional Ritron mounting kit RQX-HDMK

Mounting the HD-Series Callbox using 4 brackets included with the radio

The HD-Series callbox can be mounted to virtually any surface with four (4) ¼" diameter fasteners, not included. Choose a type of screw thread and screw length which will hold firmly in the surface to which the unit will be mounted.

1. Install the 4 mounting brackets to the back of the HD-Series Callbox case as shown with the #10-32 bolts provided. The mounting brackets can be installed vertically, as shown, or horizontally.
2. Position the HD-Series Callbox in the chosen installation location and secure it in place with four screws through the mounting brackets.

Mounting the HD-Series Callbox using the optional RQX-HDMK

The HD-Series Callbox can be mounted to a gooseneck pedestal or a post using the optional RQX-HDMK mounting bracket. The RQX-HDMK includes hardware necessary to attach the bracket to the HD-Series Callbox, but does not include hardware for attaching to a gooseneck pedestal or a post.

1. Install the optional RQX-HDMK mounting bracket onto the gooseneck pedestal with 4 screws (not included in kit) through the angled slots.
2. Mate the HD-Series Callbox to the bracket on the gooseneck pedestal or a post and secure with the four (4) T-25 Torx screws included with the RQX-HDMK.
3. If a cable to the HD-Series Callbox is required, route through the center hole in the RQX-HDMK bracket.
Route the cable into the callbox through the hole drilled in the green HD-Series case as described in the CONNECTING TO THE HD ACCESSORY CABLE section on page 9 of this manual.



HD-Series Callbox with 4 Mounting Brackets included with the radio



HD-Series Callbox with optional RQX-HDMK Mounting Bracket

HD-SERIES FIELD PROGRAMMING OVERVIEW

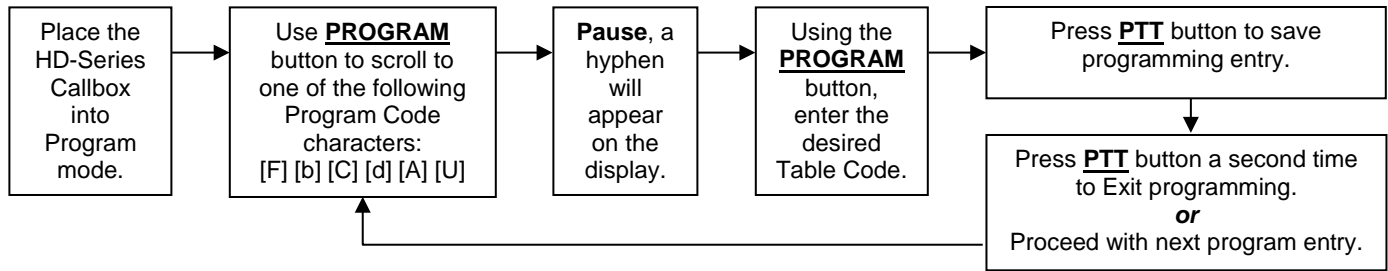

Program Codes

Table Codes



Enter a 2-digit or 3-digit Frequency code from Table 1.



Enter a 2-digit Quiet Call code from Table 2 or a 3-digit Digital Quiet Call code from Table 3.



For Paging, GateGuard® and Listen In Decode:

Enter a 2-digit, 2-Tone Paging code from Table 4 **or**

Enter **1** plus any 3–7 digit DTMF Code **or**

Enter **2** plus any 3–7 digit Selcall Code

Enter **3** plus any 2-digit, 2-Tone Paging code from Table 4 for **Secondary or**

Enter **31** plus any 3–7 digit DTMF Code for **Secondary or**

Enter **32** plus any 3–7 digit Selcall Code for **Secondary**

Enter a 3-digit Switch Operation Code

Enter 3-digit Features Codes



For Encode ANI:

Enter a **1** plus any 3–7 digit DTMF Code **or**

Enter a **2** plus any 3–7 digit Selcall Code



Enter any 2-digit or 3-digit RQX Feature code from Table 5 to:

- Enable or disable Companding.
- Enable or disable Call Tone.
- Enable or disable External +12VDC operation.
- Enable or disable Automatic Turn-Off.
- Enable or disable Busy Channel TX Inhibit.
- Set microphone gain high or low.
- Set RQX Reset Time.
- Reset RQX to Factory default programming.
- Record and Playback Voice Messages.
- Readout codes currently programmed into the RQX.



Enter the desired Speaker Volume Level as a 2–digit number from 05 – 99.

HOW TO FIELD PROGRAM FREQUENCY & TONE CODES

To match other radios, the owner can select Frequency, Tone and DQC Codes from [Table 1](#), [Table 2](#) and [Table 3](#). In our example, we will program an RQX-427-HD to operate on the "Brown Dot" frequency of 464.500 MHz with 100.0 Hz tone.

NOTES:















- | | |
|---|---|
| 22 | 1. Refer to Table 1 on page 14 to determine the two-digit frequency code and write it down. |
| 12 | 2. Refer to Table 2 on page 15 to determine the two-digit tone code for 100.0 Hz and write it down. |
| | 3. Using the T-25 Torx bit included with the radio, loosen the two captured Torx screws on the front of the hinged HD case and open. |
| | 4. Leave the batteries connected to the radio. Make sure the unit has batteries installed.
NOTE: The voltage of the batteries must be greater than 6 VDC to program properly. |
| | 5. Press and release the ON/PTT button on the front of the unit to turn the radio on. |
|  | 6. Press and HOLD the Program Button (See FIG-2 on page 8 for location). A "P" will appear on the program display as you enter program mode and the radio will beep rapidly. |
|  | 7. Release the program button after the beeping has stopped. The radio will emit a triple beep indicating that the radio is in program mode and a hyphen will appear on the program display. |
|  | 8. Click the Program button until the program display shows the Program Code "F". Pause—the radio will sound a low tone and show a hyphen across the center of the display to indicate that it is ready to accept the 2 or 3-digit Frequency code from Table 1. |
|  | 9. Enter the 1 st digit of the frequency code by clicking the Program button until the program display shows the desired number. Pause—the radio will sound a low tone and show a hyphen across the center of the display to indicate that it is ready to accept the next digit. |
|  | 10. Enter the 2 nd digit of the frequency code by clicking the Program button until the program display shows the desired number. Pause—the radio sounds a low tone and will show a hyphen across the center of the display to indicate that it is ready to accept the next digit. |
|  | 11. If necessary, enter the 3 rd digit of the frequency code by clicking the Program button until the program display shows the desired number. Pause—the radio sounds a low tone and will show a hyphen across the center of the display to indicate that it is ready to accept the next digit. |
|  | 12. Press and release the ON/PTT button to save your programming. A triple beep will sound to indicate that programming was successful and a hyphen will appear on the program display. The radio is now ready for another program entry. |
|  | NOTE: An error tone will sound if you attempt to save an incorrect code, an "E" will appear on the display. Check the digits you are attempting to enter, then re-enter. This will also occur if the radio frequency has been PC programmed to something other than one of the table codes from Table 1. |
|  | 13. Click the Program button until the program display shows the Program Code "b". Pause—the radio will sound a low tone and show a hyphen across the center of the display to indicate that it is ready to accept the 2-digit Quiet-Call code or 3-digit Digital Quiet-Call code from Table 2 or Table 3. |
|  | 14. Enter the 1 st digit of the tone code (or 1 st digit of the DQC code) by clicking the Program button until the program display shows the desired number. Pause—the radio sounds a low tone and will show a hyphen across the center of the display to indicate that it is ready to accept the next digit. |
|  | 15. Enter the 2 nd digit of the tone code (or 2 nd digit of the DQC code) by clicking the Program button until the program display shows the desired number. Pause—the radio sounds a low tone and will show a hyphen across the center of the display to indicate that it is ready to accept the next digit. |
|  | 16. FOR DQC CODES ONLY – Enter the 3 rd digit of the DQC code by clicking the Program button until the program display shows the desired number. Pause—the radio sounds a low tone and will show a hyphen across the center of the display to indicate that it is ready to accept the next digit. |
|  | 17. Press and release the ON/PTT button to save your programming. A triple beep will sound to indicate that programming was successful and a hyphen will appear on the program display. The radio is now ready for another program entry. |
|  | NOTE: An error tone will sound if you attempt to save an incorrect code, an "E" will appear on the display. Check the digits you are attempting to enter, then re-enter. |
| | 18. Once you have made your final program entry, press the ON/PTT button a final time to turn the radio off. Turn the radio back on for normal operation. |

TABLE 1: PROGRAMMABLE FREQUENCY CODES.....

UHF Business Band Models				UHF Business Band Models				VHF Business Band Models			
Code	Frequency	Color Dot	BW	Code	Frequency	Color Dot	BW	Code	Frequency	Color Dot	BW
09	469.2625		12.5 †	66	466.3125		12.5	03	151.6250	Red Dot	12.5 †
10	462.5750	White Dot	12.5 †	67	466.3375		12.5	04	151.9550	Purple Dot	12.5 †
11	462.6250	Black Dot	12.5 †	68	466.3625		12.5	05	151.9250		12.5 †
12	462.6750	Orange Dot	12.5 †	69	467.7875		12.5	06	154.5400		12.5 †
13	464.3250		12.5 †	70	467.8375		12.5	07	154.5150		12.5 †
14	464.8250		12.5 †	71	467.8625		12.5	08	154.6550		12.5 †
15	469.5000		12.5 †	72	467.8875		12.5	09	151.6850		12.5 †
16	469.5500		12.5 †	73	467.9125		12.5	10	151.7150		12.5 †
17	463.2625		12.5 †	74	469.4875		12.5	11	151.7750		12.5 †
18	464.9125		12.5 †	75	469.5125		12.5	12	151.8050		12.5 †
19	464.6000		12.5 †	76	469.5375		12.5	13	151.8350		12.5 †
20	464.7000		12.5 †	77	469.5625		12.5	14	151.8950		12.5 †
21	462.7250		12.5 †	78	462.1875		12.5	15	154.4900		12.5 †
22	464.5000	Brown Dot	12.5	79	462.4625		12.5	16	151.6550		12.5 †
23	464.5500	Yellow Dot	12.5	80	462.4875		12.5	17	151.7450		12.5 †
24	467.7625	J	12.5	81	462.5125		12.5	18	151.8650		12.5 †
25	467.8125	K	12.5	82	467.1875		12.5	24	151.7000		12.5
26	467.8500	Silver Star	12.5	83	467.4625		12.5	25	151.7600		12.5
27	467.8750	Gold Star	12.5	84	467.4875		12.5	26	152.7000		12.5 †
28	467.9000	Red Star	12.5	85	467.5125		12.5	27	152.8850		12.5
29	467.9250	Blue Star	12.5	86	451.1875		12.5	28	152.9150		12.5
30	461.0375		12.5	87	451.2375		12.5	29	152.9450		12.5
31	461.0625		12.5	88	451.2875		12.5	30	151.5125		12.5
32	461.0875		12.5	89	451.3375		12.5	31	154.5275		12.5
33	461.1125		12.5	90	451.4375		12.5	32	153.0050		12.5
34	461.1375		12.5	91	451.5375		12.5	33	158.4000		12.5
35	461.1625		12.5	92	451.6375		12.5	34	158.4075		12.5
36	461.1875		12.5	93	452.3125		12.5				
37	461.2125		12.5	94	452.5375		12.5				
38	461.2375		12.5	95	452.4125		12.5				
39	461.2625		12.5	96	452.5125		12.5				
40	461.2875		12.5	97	452.7625		12.5				
41	461.3125		12.5	98	452.8625		12.5				
42	461.3375		12.5	99	456.1875		12.5				
43	461.3625		12.5	100	456.2375		12.5				
44	462.7625		12.5	101	456.2875		12.5				
45	462.7875		12.5	102	468.2125		12.5				
46	462.8125		12.5	103	468.2625		12.5				
47	462.8375		12.5	104	468.3125		12.5				
48	462.8625		12.5	105	468.3625		12.5				
49	462.8875		12.5	106	468.4125		12.5				
50	462.9125		12.5	107	468.4625		12.5				
51	464.4875		12.5	108	468.5125		12.5				
52	464.5125		12.5	109	468.5625		12.5				
53	464.5375		12.5	110	468.6125		12.5				
54	464.5625		12.5	111	468.6625		12.5				
55	466.0375		12.5	112	456.3375		12.5				
56	466.0625		12.5	113	456.4375		12.5				
57	466.0875		12.5	114	456.5375		12.5				
58	466.1125		12.5	115	456.6375		12.5				
59	466.1375		12.5	116	457.3125		12.5				
60	466.1625		12.5	117	457.4125		12.5				
61	466.1875		12.5	118	457.5125		12.5				
62	466.2125		12.5	119	457.7625		12.5				
63	466.2375		12.5	120	457.8625		12.5				
64	466.2625		12.5	121	461.3175		12.5				
65	466.2875		12.5	122	464.8375		12.5				

VHF MURS Models**			
Code	Frequency	Color Dot	BW
01	154.600	Green Dot	25.0
02	154.570	Blue Dot	25.0
19	151.820	MURS	12.5
20	151.880	MURS	12.5
21	151.940	MURS	12.5
22	154.600	MURS	12.5
23	154.570	MURS	12.5

Notes
** MURS models do not require an FCC license. All other models require an FCC license.
† Frequency code was 25 KHz bandwidth prior to the 2013 FCC Narrowband Mandate.
• BW is the bandwidth in kHz.
• 12.5 kHz indicates a narrow band channel, 25 kHz indicates a wide band channel.
• If the callbox has been PC programmed to a non-table frequencies it cannot be changed via field programming. Code 999 will appear when read out.

CANADIAN FREQUENCY CODES.....

<i>Canada Models UHF Business Band</i>				<i>Canada Models VHF Business Band</i>			
Code	Frequency	Color Dot	BW	Code	Frequency	Color Dot	BW
01	458.6625		25	01	151.055		25
02	469.2625		25	02	151.115		25

TABLE 2: PROGRAMMABLE QC TONE CODES

Code	Frequency	Code	Frequency	Code	Frequency	Code	Frequency
01	67.0	14	107.2	27	167.9	40	159.8
02	71.9	15	110.9	28	173.8	41	165.5
03	74.4	16	114.8	29	179.9	42	171.3
04	77.0	17	118.8	30	186.2	43	177.3
05	79.7	18	123.0	31	192.8	44	No Tone
06	82.5	19	127.3	32	203.5	45	183.5
07	85.4	20	131.8	33	210.7	46	189.9
08	88.5	21	136.5	34	218.1	47	196.6
09	91.5	22	141.3	35	225.7	48	199.5
10	94.8	23	146.2	36	233.6	49	206.5
11	97.4	24	151.4	37	241.8	50	229.1
12	100.0	25	156.7	38	250.3	51	254.1
13	103.5	26	162.2	39	69.4	00	No Tone

TABLE 3: PROGRAMMABLE DIGITAL DQC TONE CODES.....

Code	Code	Code	Code	Code	Code	Code	Code
023	072	152	244	311	412	466	631
025	073	155	245	315	413	503	632
026	074	156	246	325	423	506	645
031	114	162	251	331	431	516	654
032	115	165	252	332	432	523	664
036	116	172	255	343	445	532	703
043	122	174	261	346	446	546	712
047	125	205	263	351	452	565	723
051	131	212	265	356	454	606	731
053	132	223	266	364	455	662	732
054	134	225	271	365	462	612	734
065	143	226	274	371	464	624	743
071	145	243	306	411	465	627	754

HOW TO FIELD PROGRAM 2-TONE, DTMF OR SELCALL DECODE (RECEIVE) OPERATION.....

For special applications, it is desirable to program the HD-Series Callbox for 2-Tone, DTMF or Selcall decode (receive) operation. The user is able to field program the radio for one of the 9 pre-determined tone pairs specified in **Table 4 on page 18**, or for any 3-7 digit DTMF or Selcall sequence. The 2-Tone codes correspond to field programmable 2-Tone encode (transmit) codes available in other RITRON portable and base radios.

Programming the radio for 2-Tone, DTMF or Selcall decode operation **MUST BE DONE IN THE FOLLOWING ORDER!**

1. Program the desired Operation code (Refer to Table 4). This will delete any previous Primary or Secondary Decode code programming.
2. Program the desired 2-Tone, DTMF or Selcall Primary Decode code (Refer to Table 4). An "E" error indication will appear on the display if the programmed Operation code does not require a Primary Decode code.
3. If required, program the desired 2-Tone, DTMF or Selcall Secondary Decode code (Refer to Table 4). An "E" error indication will appear on the display if the programmed Operation code does not require a Secondary Decode code.
 - The Secondary Decode code **must be the same type as the Primary Decode code**. For example, if the Primary Decode code was set for DTMF, the Secondary Decode code must also be DTMF.
 - The Secondary Decode code **cannot be the same as the Primary Decode code**.
 - If using DTMF or Selcall, the **Primary and Secondary Decode codes must have the same number of digits**.
4. Program the desired Features code (Refer to Table 4).

In the following example we will program an RQX-427-HD for paging operation with 2-Tone Decode Code 94 frequencies of 389.0 and 669.9 Hz, and for Listen In operation with 2-Tone Decode Code 95 frequencies of 410.8 and 707.3 Hz. The Listen In time will be set for 10 seconds.

	1.	Using the T-25 Torx bit included with the radio, loosen the two captured Torx screws on the front of the hinged HD case and open.
	2.	Leave the batteries connected to the radio. Make sure the unit has batteries installed. NOTE: The voltage of the batteries must be greater than 6 VDC to program properly.
	3.	Press and release the ON/PTT button on the front of the unit to turn the radio on.
	4.	Press and HOLD the Program Button (See FIG-2 on page 8 for location). A "P" will appear on the program display as you enter program mode and the radio will beep rapidly. Release the program button after the beeping has stopped. The radio will emit a triple beep indicating that the radio is in program mode and a hyphen will appear on the program display.
	5.	Refer to Table 4 on page 18 to determine the three-digit Operation code for Paging and Listen In operation.
OPERATION CODE	6.	Click the Program button until the program display shows the Program Code "C". Pause—the radio will sound a low tone and show a hyphen across the center of the display to indicate that it is ready to accept the next programming code.
	7.	Enter the 1 st digit of the Operation Code by clicking the Program button until the program display shows the desired number. Pause—the radio will sound a low tone and show a hyphen across the center of the display to indicate that it is ready to accept the next digit.
	8.	Enter the 2 nd digit of the Operation Code by clicking the Program button until the program display shows the desired number. Pause—the radio sounds a low tone and will show a hyphen across the center of the display to indicate that it is ready to accept the next digit.
	9.	Enter the 3 rd digit of the Operation Code by clicking the Program button until the program display shows the desired number. Pause—the radio sounds a low tone and will show a hyphen across the center of the display to indicate that it is ready to accept the next digit.
	10.	Press and release the ON/PTT button to save your programming. A triple beep will sound to indicate that programming was successful and a hyphen will appear on the program display. The radio is now ready for another program entry. NOTE: An error tone will sound if you attempt to save an incorrect code, an "E" will appear on the display. Check the digits you are attempting to enter, then re-enter.
	11.	Refer to Table 4 on page 18 to determine the two-digit code for 2-tone decode on 389.0 and 669.9 Hz.
	12.	Click the Program button until the program display shows the Program Code "C". Pause—the radio will sound a low tone and show a hyphen across the center of the display to indicate that it is ready to accept a 2-digit 2-Tone code from Table 4, or a 3 to 7-digit DTMF or Selcall decode sequence.
	13.	FOR DTMF CODES ONLY – Enter a "1" using the Program button. Pause—the radio will sound a low tone and show a hyphen across the center of the display to indicate that it is ready to accept the next digit.
	14.	FOR SELCALL CODES ONLY – Enter a "2" using the Program button. Pause—the radio will sound a low tone and show a hyphen across the center of the display to indicate that it is ready to accept the next digit.
2-TONE, DTMF OR SELCALL CODE	15.	Enter the 1 st digit of the 2-Tone code (or 1 st digit of the DTMF or Selcall code) by clicking the Program button until the program display shows the desired number. Pause—the radio will sound a low tone and show a hyphen across the center of the display to indicate that it is ready to accept the next digit.
	16.	Enter the 2 nd digit of the 2-Tone code (or 2 nd digit of the DTMF or Selcall code) by clicking the Program button until the program display shows the desired number. Pause—the radio sounds a low tone and will show a hyphen across the center of the display to indicate that it is ready to accept the next digit.
	17.	FOR DTMF OR SELCALL CODES ONLY – Enter the 3 rd digit of the DTMF or Selcall decode sequence. Pause—the radio sounds a low tone and will show a hyphen across the center of the display to indicate that it is ready to accept the next digit. Continue entering up to seven digits.

HOW TO FIELD PROGRAM 2-TONE, DTMF OR SELCALL DECODE (RECEIVE) OPERATION (CONTINUED)

- | | | |
|------------------------------|--|---|
| | | 18. Press and release the ON/PTT button to save your programming. A triple beep will sound to indicate that programming was successful and a hyphen will appear on the program display. The radio is now ready for another program entry.
NOTE: An error tone will sound if you attempt to save an incorrect code, an "E" will appear on the display. Check the digits you are attempting to enter, then re-enter. |
| | | 19. Refer to Table 4 on page 18 to determine the two-digit code for 2-tone decode on 410.8 and 707.3 Hz. |
| | | 20. Click the Program button until the program display shows the Program Code "C". Pause—the radio will sound a low tone and show a hyphen across the center of the display to indicate that it is ready to accept the next programming code. |
| | | 21. Enter a "3" using the Program button to indicate Secondary code programming. Pause—the radio will sound a low tone and show a hyphen across the center of the display to indicate that it is ready to accept the next digit. |
| | | 22. FOR DTMF CODES ONLY – Enter a "1" using the Program button. Pause—the radio will sound a low tone and show a hyphen across the center of the display to indicate that it is ready to accept the next digit. |
| | | 23. FOR SELCALL CODES ONLY – Enter a "2" using the Program button. Pause—the radio will sound a low tone and show a hyphen across the center of the display to indicate that it is ready to accept the next digit. |
| 2-TONE, DTMF OR SELCALL CODE | | 24. Enter the 1 st digit of the 2-Tone code (or 1 st digit of the DTMF or Selcall code) by clicking the Program button until the program display shows the desired number. Pause—the radio will sound a low tone and show a hyphen across the center of the display to indicate that it is ready to accept the next digit. |
| | | 25. Enter the 2 nd digit of the 2-Tone code (or 2 nd digit of the DTMF or Selcall code) by clicking the Program button until the program display shows the desired number. Pause—the radio sounds a low tone and will show a hyphen across the center of the display to indicate that it is ready to accept the next digit. |
| | | 26. FOR DTMF OR SELCALL CODES ONLY – Enter the 3 rd digit of the DTMF or Selcall decode sequence. Pause—the radio sounds a low tone and will show a hyphen across the center of the display to indicate that it is ready to accept the next digit. Continue entering up to seven digits. |
| | | 27. Press and release the ON/PTT button to save your programming. A triple beep will sound to indicate that programming was successful and a hyphen will appear on the program display. The radio is now ready for another program entry.
NOTE: An error tone will sound if you attempt to save an incorrect code, an "E" will appear on the display. Check the digits you are attempting to enter, then re-enter. |
| | | 28. Refer to Table 4 on page 18 to determine the three-digit Features code for 10 second Listen In operation. |
| FEATURES CODE | | 29. Click the Program button until the program display shows the Program Code "C". Pause—the radio will sound a low tone and show a hyphen across the center of the display to indicate that it is ready to accept the next programming code. |
| | | 30. Enter the 1 st digit of the Features Code by clicking the Program button until the program display shows the desired number. Pause—the radio will sound a low tone and show a hyphen across the center of the display to indicate that it is ready to accept the next digit. |
| | | 31. Enter the 2 nd digit of the Features Code by clicking the Program button until the program display shows the desired number. Pause—the radio sounds a low tone and will show a hyphen across the center of the display to indicate that it is ready to accept the next digit. |
| | | 32. Enter the 3 rd digit of the Features Code by clicking the Program button until the program display shows the desired number. Pause—the radio sounds a low tone and will show a hyphen across the center of the display to indicate that it is ready to accept the next digit. |
| | | 33. Press and release the ON/PTT button to save your programming. A triple beep will sound to indicate that programming was successful and a hyphen will appear on the program display. The radio is now ready for another program entry.
NOTE: An error tone will sound if you attempt to save an incorrect code, an "E" will appear on the display. Check the digits you are attempting to enter, then re-enter. |
| | | 34. Once you have made your final program entry, press the ON/PTT button a final time to turn the radio off. Turn the radio back on for normal operation. |

IMPORTANT NOTES:

- Typically, 2-Tone, DTMF or Selcall Primary decode is used to selectively call an RQX Callbox. When using 2-Tone, DTMF or Selcall decode for special applications (GateGuard® or Listen-In) the associated Operation Code must also be entered. Programming for operation listed below will cause the RQX to use the 2-tone, DTMF or Selcall codes for their special application and not be used to screen calls.

<u>Primary Decode used for selective calling</u>	<u>Primary Decode used for special application</u>	<u>Secondary Decode used</u>
No Switch	GateGuard® momentary	Switch ON when active with Turn Off code
Switch ON when called	GateGuard® toggle	Listen In
Switch ON when active	GateGuard® On/Off	GateGuard® On/Off
- Your Ritron dealer can PC program the callbox to additional features associated with the 2-tone, DTMF or Selcall decode function. Contact your Ritron dealer for details.
- When the callbox is programmed for 2-Tone Decode operation, it is recommended that you do NOT use QC Tone Codes greater than "23" (146.2 Hz).

TABLE 4: PAGING, GATEGUARD® AND LISTEN IN DECODE CODES

Code	Feature	Key	Description
2-Tone Codes			
90	See Note		<ul style="list-style-type: none"> 2-Tone codes can be used for Paging or GateGuard® switch operation. If the Callbox displays 2-Tone Code “90” on readout it has been programmed for custom frequencies. When the callbox is programmed for 2-Tone Decode operation, it is recommended that you do NOT use QC Tone Codes greater than “23” (146.2 Hz).
91	330.5 569.1		
92	349.0 600.9		
93	368.5 634.5		
94	389.0 669.9		
95	410.8 707.3		
96	433.7 746.8		
97	457.9 788.5		
98	483.5 832.5		
99	330.5 600.9		
DTMF and Selcall Codes			
1 + xxx	DTMF		Enter “1” and 3-7 DTMF digits for Primary Decode (0123456789)
2 + xxx	Selcall		Enter “2” and 3-7 Selcall digits for Primary Decode. (0123456789)
Secondary 2-Tone, DTMF and Selcall Codes			
3 + xx	2-Tone		Enter “3” and the 2-digit 2-tone code for Secondary Decode
31 + xxx	DTMF		Enter “31” and 3-7 DTMF digits for Secondary Decode (0123456789)
32 + xxx	Selcall		Enter “32” and 3-7 Selcall digits for Secondary Decode. (0123456789)
Operation Codes			
401	No Switch	√	Disables all switch, paging and Listen In operation. No decoding required.
402	No Switch, Paging		Paging enabled uses Primary Decode code only.
403	No Switch, Listen In		Listen In operation uses Secondary code only.
404	No Switch, Paging, Listen In		Paging operation using Primary Decode code, Listen In operation using Secondary Decode code.
405	Switch On when called		Switch closes (e.g. strobe light turns on) when Callbox 1 st receives a call. Switch opens (e.g. strobe light turns off) as soon as the PTT is pressed, or if the Callbox has not been used (transmit or receive) for a period of time longer than RQX Reset Time. No decoding required.
406	Switch On when called, Paging		Paging enabled uses Primary Decode code only.
407	Switch On when called, Listen In		Listen In operation uses Secondary code only.
408	Switch On when called, Paging, Listen In		Paging operation using Primary Decode code, Listen In operation using Secondary Decode code.
409	Switch On when active		Switch is closed (e.g. strobe light turns on) as long as Callbox is in use. Switch opens (e.g. strobe light turns off) when Callbox has not been used (transmit or receive) for a period of time longer than RQX Reset Time. No decoding required.
410	Switch On when active, Paging		Paging enabled uses Primary Decode code only.
411	Switch On when active, Listen In		Listen In operation uses Secondary code only.
412	Switch On when active, Paging, Listen In		Paging operation using Primary Decode code, Listen In operation using Secondary Decode code.
413	Switch On when active with Turn Off code		Switch is closed (e.g. strobe light turns on) when the Callbox receives or transmits a message, and will remain on until the correct 2-Tone, DTMF or Selcall Secondary Decode Code is received. No Primary code required.
414	Switch On when active with Turn Off code Paging		Paging enabled uses Primary Decode code. Secondary code is used for Switch Turn Off.
415	GateGuard® Switch momentary		Switch is closed for 1 second when the correct 2-Tone, DTMF or Selcall Primary Decode Code is received. No Secondary Decode code required.
416	GateGuard® Switch momentary, Listen In		Momentary switch operation uses Primary Decode Code, Listen In uses Secondary Decode code.
417	GateGuard® Switch toggle		Switch alternately closes and opens when the correct 2-Tone, DTMF or Selcall Primary Decode Code is received. No Secondary Decode code required.
418	GateGuard® Switch toggle, Listen In		Toggle switch operation uses Primary Decode Code, Listen In uses Secondary Decode code.
419	GateGuard® Switch On/Off code		Switch is closed when the correct 2-Tone, DTMF or Selcall Primary Decode Code is received, and opened when the correct 2-Tone, DTMF or Selcall Secondary Decode Code is received.

KEY: √ The Callbox is set from the factory with these options **enabled**.











TABLE 4: PAGING, GATEGUARD® AND LISTEN IN DECODE CODES

Code	Feature	Key	Description
Primary Decode Features			
510	Primary Ring Tone OFF		No Ring signal on Primary decode.
511	Primary Ring Tone ON	√	Callbox will sound a Ring signal in the speaker upon Primary decode.
520	Primary Transpond OFF		No Transpond transmission on Primary decode.
521	Primary Transpond ON	√	Callbox will transmit a Transpond tone to acknowledge Primary decode.
530	Primary Decode without subtone	√	Primary Decode code is decoded with or without subtone present.
531	Primary Decode with subtone		Primary Decode code is only decoded with the correct subtone present.
Secondary Decode Features			
550	Secondary Ring Tone OFF	√	No Ring signal on Secondary decode.
551	Secondary Ring Tone ON		Callbox will sound a Ring signal in the speaker upon Secondary decode.
560	Secondary Transpond OFF	√	No Transpond transmission on Secondary decode.
561	Secondary Transpond ON		Callbox will transmit a Transpond tone to acknowledge Secondary decode
570	Secondary Decode without subtone	√	Secondary Decode code is decoded with or without subtone present.
571	Secondary Decode with subtone		Secondary Decode code is only decoded with the correct subtone present.
Listen In Time Features			
581	Listen In 5 seconds	√	The Callbox will automatically transmit for a period of time equal to the Listen In Time when the correct 2-Tone, DTMF or Selcall Secondary Decode Code is received.
582	Listen In 10 seconds		
583	Listen In 20 seconds		
584	Listen In 30 seconds		

KEY: √ The Callbox is set from the factory with these options **enabled**.

HOW TO FIELD PROGRAM DTMF OR SELCALL ENCODE ANI (TRANSMIT) CODES.....

Each Callbox can be uniquely identified by programming for DTMF or Selcall encode ANI (transmit) operation. The user is able to field program the radio for any 3-7 digit DTMF or Selcall sequence. The radio will transmit the ID code at the beginning of each transmission. In our example we will program an RQX-427-HD to operate with a DTMF ANI Code of "547".

- | | |
|---|--|
| 547 | <ol style="list-style-type: none"> 1. Write down the desired DTMF or Selcall ANI code. 2. Using the T-25 Torx bit included with the radio, loosen the two captured Torx screws on the front of the hinged HD case and open. |
| | <ol style="list-style-type: none"> 3. Leave the batteries connected to the radio. Make sure the unit has batteries installed.
NOTE: The voltage of the batteries must be greater than 6 VDC to program properly. 4. Press and release the ON/PTT button on the front of the unit to turn the radio on. |
|  | <ol style="list-style-type: none"> 5. Press and HOLD the Program Button (See FIG-2 on page 8). A "P" will appear on the program display as you enter program mode and the radio will beep rapidly. |
|  | <ol style="list-style-type: none"> 6. Release the program button after the beeping has stopped. The radio will emit a triple beep indicating that the radio is in program mode and a hyphen will appear on the program display. |
|  | <ol style="list-style-type: none"> 7. Click the Program button until the program display shows the Program Code "d". Pause—the radio will sound a low tone and show a hyphen across the center of the display to indicate that it is ready to accept a 3 to 7-digit DTMF or Selcall encode ANI sequence. |
|  | <ol style="list-style-type: none"> 8. FOR DTMF CODES ONLY – Enter a "1" |
|  | <ol style="list-style-type: none"> 9. FOR SELCALL CODES ONLY – Enter a "2" |
|  | <ol style="list-style-type: none"> 10. Enter the 1st digit of the DTMF or Selcall code by clicking the Program button until the program display shows the desired number. Pause—the radio will sound a low tone and show a hyphen across the center of the display to indicate that it is ready to accept the next digit. |
|  | <ol style="list-style-type: none"> 11. Enter the 2nd digit of the DTMF or Selcall code by clicking the Program button until the program display shows the desired number. Pause—the radio sounds a low tone and will show a hyphen across the center of the display to indicate that it is ready to accept the next digit. |
|  | <ol style="list-style-type: none"> 12. Enter the 3rd digit of the DTMF or Selcall decode sequence by clicking the Program button until the program display shows the desired number. Pause—the radio sounds a low tone and will show a hyphen across the center of the display to indicate that it is ready to accept the next digit. Continue entering up to seven digits. |
|  | <ol style="list-style-type: none"> 13. Press and release the ON/PTT button to save your programming. A triple beep will sound to indicate that programming was successful and a hyphen will appear on the program display. The radio is now ready for another program entry.
NOTE: An error tone will sound if you attempt to save an incorrect code, an "E" will appear on the display. Check the digits you are attempting to enter, then re-enter. |
|  | <ol style="list-style-type: none"> 14. Once you have made your final program entry, press the ON/PTT button a final time to turn the radio off. Turn the radio back on for normal operation. |

DTMF OR SELCALL CODE

HOW TO FIELD PROGRAM FEATURE CODES.....

The HD-Series Callbox can be field programmed for a number of advanced features. Refer to **Table 5** for the two or three digit codes available for field programming. In our example we will program an RQX-427-HD for an RQX Reset Time of 30 seconds.











- | | |
|---|--|
| 04 | <ol style="list-style-type: none"> 1. Refer to Table 5 to determine the two or three-digit feature code and write it down. 2. Using the T-25 Torx bit included with the radio, loosen the two captured Torx screws on the front of the hinged HD case and open. |
|  | <ol style="list-style-type: none"> 3. Leave the batteries connected to the radio. Make sure the unit has batteries installed.
NOTE: The voltage of the batteries must be greater than 6 VDC to program properly. 4. Press and release the ON/PTT button on the front of the unit to turn the radio on. |
|  | <ol style="list-style-type: none"> 5. Press and HOLD the Program Button (See FIG-2 on page 8). A "P" will appear on the program display as you enter program mode and the radio will beep rapidly. |
|  | <ol style="list-style-type: none"> 6. Release the program button after the beeping has stopped. The radio will emit a triple beep indicating that the radio is in program mode and a hyphen will appear on the program display. |
|  | <ol style="list-style-type: none"> 7. Click the Program button until the program display shows the Program Code "A". Pause—the radio will sound a low tone and show a hyphen across the center of the display to indicate that it is ready to accept a 2-digit or a 3-digit Feature code. |
| FEATURE CODE | <ol style="list-style-type: none"> 8. Enter the 1st digit of the feature code by clicking the Program button until the program display shows the desired number. Pause—the radio will sound a low tone and show a hyphen across the center of the display to indicate that it is ready to accept the next digit. |
|  | |
|  | <ol style="list-style-type: none"> 9. Enter the 2nd digit of the feature code (if necessary) by clicking the Program button until the program display shows the desired number. Pause—the radio sounds a low tone and will show a hyphen across the center of the display to indicate that it is ready to accept the next digit. |
|  | |
|  | <ol style="list-style-type: none"> 10. Enter the 3rd digit of the feature code (if necessary) by clicking the Program button until the program display shows the desired number. Pause—the radio sounds a low tone and will show a hyphen across the center of the display to indicate that it is ready to accept the next digit. |
|  | |
|  | <ol style="list-style-type: none"> 11. Press and release the ON/PTT button to save your programming. A triple beep will sound to indicate that programming was successful and a hyphen will appear on the program display. The radio is now ready for another program entry.
NOTE: An error tone will sound if you attempt to save an incorrect code, an "E" will appear on the display. Check the digits you are attempting to enter, then re-enter. |
|  | |
| | <ol style="list-style-type: none"> 12. Once you have made your final program entry, press the ON/PTT button a final time to turn the radio off. Turn the radio back on for normal operation. |

TABLE 5: ADVANCED FEATURE CODES

Code	Feature	Key	Description
RQX Reset Time			
01	5 seconds		RQX Reset Time is the length of time the RQX Callbox can remain inactive (not receiving or transmitting) before it automatically shuts off.
02	10 seconds	√	
03	20 seconds		
04	30 seconds		
05	45 seconds		
06	1 minute		
07	2 minutes		
08	3 minutes		
09	4 minutes		
Special Features			
21	Reset to Factory Defaults		Resets all Callbox features that can be field programmed to Factory default programming.
22	Display Radio Revision		Callbox will display a sequence of 6 digits to identify operating code revision. This is helpful when troubleshooting the radio.
230	Disable External +12 VDC	√	Disables the External +12 VDC “Loss of power” notification and reverts back to “Low Battery” notification.
231	Enable External +12 VDC		Enables the External +12 VDC “Loss of power” notification feature.
240	Disable Auto Turn-Off		Callbox will remain on at all times. This mode of operation is not recommended for battery-powered applications.
241	Enable Auto Turn-Off	√	Callbox will automatically turn off when it has not been used (transmit or receive) for a period of time longer than the RQX Reset Time.
250	Disable Busy Channel TX Inhibit	√	Callbox will transmit whenever the PTT is pressed, regardless of any received signal.
251	Enable Busy Channel TX Inhibit		Callbox cannot transmit when there is a received signal. A “busy signal” will be heard on the Callbox speaker when the PTT is pressed and a received signal is present.
260	Mic Gain Normal	√	Places the microphone into normal gain operation for the majority of applications where the user is talking directly into the Callbox. This mode of operation will decrease background noise transmitted by the Callbox.
261	Mic Gain High		Places the microphone into high gain operation where quiet and distant voices will be heard. This mode of operation will increase background noise transmitted by the Callbox.
270	Companding OFF	√	Turns Companding off.
271	Companding ON		Companding will compress transmit audio before sending it, and expand receive audio before it is heard on the speaker to reduce the background noise common in radio communications. Companding is not recommended unless all radios in the system are companded.
280	Call Tone OFF		Disables Call Tone.
281	Call Tone ON - Low	√	When PTT button is initially pressed a Call Tone will be transmitted at a low level.
282	Call Tone ON – High		When PTT button is initially pressed a Call Tone will be transmitted at a high level.
Record Voice Messages			
31	Voice Alert (4 sec. max)		Once recorded, the message is transmitted when the PTT is 1st pressed.
32	Greeting Message (12 sec. max)		Once recorded, the message plays on speaker when the PTT is 1st pressed.
33	Sensor Detect On (4 sec. max)		Once recorded, the message is transmitted when the Sensor Input is pulled low.
34	Sensor Detect Off (4 sec. max)		Once recorded, the message is transmitted when the Sensor Input is pulled high.
35	Low Battery (4 sec. max)		Once recorded, the message is transmitted when low battery voltage is detected.
36	Power Fail (4 sec. max)		Once recorded, the message is transmitted when a +12VDC power fail is detected.
Play Voice Messages			
41	Voice Alert		Plays the recorded message on the speaker for review.
42	Greeting Message		
43	Sensor Detect On		
44	Sensor Detect Off		
45	Low Battery		
46	Power Fail		

KEY: √ The Callbox is set from the factory with these options **enabled**.

TABLE 5: ADVANCED FEATURE CODES (CONTINUED).....

Code	Feature	Key	Description
Erase Voice Messages			
51	Voice Alert		Erases the recorded message.
52	Greeting Message		
53	Sensor Detect On		
54	Sensor Detect Off		
55	Low Battery		
56	Power Fail		
Resend Voice Alert Message			
60	0 Re-Sends	√	Number of times the Voice Alert message will be resent. The period of time between resends is the RQX Reset Time. Resend is terminated when the Callbox receives a response transmission.
61	1 Re-Sends		
62	2 Re-Sends		
63	3 Re-Sends		
64	4 Re-Sends		
65	5 Re-Sends		
Programming Readout Codes			
81	Frequency Code		Display will sequentially show the programmed 2 or 3-digit Frequency Code. (1)
82	QC or DQC Tone Code		Display will sequentially show the programmed 2-digit QC Tone Code or 3-digit DQC Tone Code. (2)
83	2-Tone, DTMF or Selcall Decode Code		Display will sequentially show the programmed 2-digit 2-Tone Code, or the 3 to 7-digit DTMF or Selcall Code. (3)
84	RQX Reset Time		Display will sequentially show the programmed 2-digit RQX Reset Time Code.(4)
85	Switch Operation		Display will sequentially show the programmed 2-digit Switch Operatiion Code.
86	Listen In Time		Display will sequentially show the programmed 2-digit Listen In Time Code. (4)
87	Receive Volume Level		Display will sequentially show the programmed 2-digit Receive Volume Level Code.(4)
88	DTMF or Selcall Encode Code		Display will sequentially show the programmed 3 to 7-digit DTMF or Selcall Code.

KEY: √ The Callbox is set from the factory with these options **enabled**.

- NOTES:**
- (1) 999 indicates a non-table frequency or that TX and RX are not the same
 - (2) If the RX and TX tone code is not the same, or if DCS is inverted you will get an ERROR indication
 - (3) Primary Decode code will be displayed.
 - (4) ERROR indication will be displayed if not a Field Programming value (has been PC programmed)

PC PROGRAMMABLE HD-SERIES CALLBOX FEATURES

The HD-Series Callbox has a variety of programmable features that determine how your callbox operates. Some of these features can be Field Programmed (FP) by you without using special tools, while other features can only be Programmed (PC) with a PC and RQX Series PC Programmer RQX-PCPS-1.0 or higher. Contact your Ritron dealer or the factory for details.

Glossary of Terms	
Intercom Mode	The Automatic Turn-Off feature has been disabled and the Callbox is able to receive calls at any time.
Sleep	If Automatic Turn-Off is DISABLED and Battery Saver is ENABLED the Callbox will go into a low current Sleep Time when it is not being used, waking up periodically to check for a received message. Pressing the ON/PTT button will wake-up the radio immediately.
Wake-Up	When Battery Saver is ENABLED and the Callbox has entered the low current Sleep state, the radio will wake-up periodically to check for a received message. The Sleep Time is set by the Battery Saver Sleep Time.
No Activity Time	A continuous period of time where the Callbox is not sending or receiving a call.

TABLE 6: PC PROGRAMMABLE FEATURES

Feature	Key	Description
Field Programming Enable		This option is ENABLED as the Factory Default setting. This permits all Field Programmable features (FP) to be field programmed by you. If DISABLED , the features can only be programmed using special Ritron PC Programming software.
Send Call Tone	√	The Factory Default setting has the Call Tone feature ON (refer to <u>HOW TO FIELD PROGRAM FEATURE CODES</u> on page 22). The callbox can be programmed to transmit a Call Tone if the Reset Time has expired and the ON/PTT button is pressed. This will alert system users that the call is originating from the callbox.
Speaker Volume	√	The Factory Default setting is medium volume. Field Programming or PC Programming allows any volume level between 5 – 100%. A lower speaker volume reduces audio distortion and provides a more natural sound. For best performance, do not set the volume any higher than is necessary for your application.
High/Low Power		If externally powered at +12VDC the HD-Series callbox can be set to transmit at high (2-Watt) or low (700 mW) power. The radio automatically operates in low power when battery powered. The Factory Default setting is high power when externally powered at +12VDC.
Automatic Turn-Off	√	<p>This feature is ENABLED as the Factory Default setting. The callbox will turn OFF when the RQX Reset Time has expired. The Reset Time is a pre-programmed amount of time of “no activity” (no calls transmitted, no calls received) before the callbox turns OFF in order to conserve battery life. The callbox can be turned back ON when the ON/PTT button is pressed. This is the recommended mode of operation for all battery only powered applications.</p> <p>If Automatic Turn-Off is NOT selected the callbox does NOT completely turn OFF, but remains in the Intercom mode, allowing the callbox to receive calls at any time.</p> <p>Operating the callbox with Automatic Turn-Off DISABLED significantly increases battery drain, and is therefore NOT recommended for battery only powered applications. Battery life can be increased using the Battery Saver Enable feature detailed in this section.</p>
RQX Reset Time	√	<p>Set from the factory for 10 seconds, the RQX Reset Time can be Field Programmed to 9 different times ranging from 5 seconds to 4 minutes, and PC programmed for 5-255 seconds. A shorter RQX Reset Time will result in increased battery life. In standard Automatic Turn-Off operation a longer RQX Reset Time will allow more time for a response before the Callbox turns off.</p> <p>RQX Reset Time defines the Inactivity Time allowed before the Callbox:</p> <ul style="list-style-type: none"> • Turns Off if Automatic Turn-Off is ENABLED. • Enters Battery Saver mode if Battery Saver is ENABLED. • Resets 2-Tone, DTMF or Selcall Paging Decode. • Automatically opens the Relay Switch Output.

KEY: √ Feature is Field Programmable.

TABLE 6: PC PROGRAMMABLE FEATURES (CONTINUED)

Feature	Key	Description
Battery Saver Enable		<p>When the HD-Series Callbox is programmed to operate with Automatic Turn-Off disabled, Battery Saver can increase battery life in both internal and external battery powered applications.</p> <p>With Battery Saver Enable, the callbox will periodically Wake-Up and listen for a received signal before returning to a low current Sleep state. The time between Wake-Up states can be PC programmed between 0.5 - 8 seconds with the Battery Saver Sleep Time setting. A longer time between Wake-Up states will result in increased battery life.</p> <p>The callbox immediately leaves Battery Saver mode any time the ON/PTT Button is pressed or a signal is received, and will not return to Battery Saver until the period of no activity exceeds the RQX Reset Time.</p>
Power Fail Alert Tone	√	<p>By selecting the +12 VDC Power Fail Alert Tone feature the callbox will look for a loss of the +12 VDC power source. The callbox will immediately transmit an Alert Tone to notify personnel that the +12 VDC source has been lost and is now operating on battery back-up. The callbox will transmit an Alert Tone once every hour until the +12 VDC power source is restored or until the back-up batteries are exhausted. Even if this feature is NOT selected, it will always revert to Back-up Battery power, see <u>Using External +12 VDC Power with Battery Back-up</u> on page 5 for details.</p>
Microphone Gain	√	<p>The Microphone can be placed in HIGH or NORMAL gain mode. With the microphone in high gain mode quiet and distant voices will be heard. This mode of operation will increase background noise transmitted by the Callbox.</p> <p>The Microphone gain is set to NORMAL mode by default. Leave the microphone in normal gain mode for the majority of applications where the user is talking directly into the Callbox. This mode of operation will decrease background noise transmitted by the Callbox.</p>
Listen In	√	<p>Listen In allows remote activation of the Callbox transmitter for a programmed period of time when the correct 2-Tone, DTMF or Selcall code is decoded.</p> <p>This feature, turned OFF by default, can be Field Programmed to 4 different transmit times ranging from 5-30 seconds and PC programmed for 1-255 seconds.</p> <p>The 2-Tone, DTMF or Selcall Decode Code required to activate the feature can be Field Programmed from the 9 different 2-Tone Decode Codes in Table 4, 3-7 digit DTMF or Selcall codes, or PC programmed for any 2-Tone frequency pair between 300-1500 Hz.</p>
Busy Channel TX Inhibit	√	<p>With this feature enabled the Callbox cannot transmit when there is a received signal. A "busy signal" will be heard on the Callbox speaker when the PTT is pressed and a received signal is present. Busy Channel TX Inhibit is disabled from the factory.</p>
Sensor/Contact Closure Input		<p>The Callbox will send a warning tone when a change in the Sensor Input is detected. The Sensor Input will respond to an OPEN or CLOSED switch.</p>
Transmit Beep Enable		<p>This feature is turned on from the factory to provide a short beep in the Callbox speaker any time the ON/PTT button is pressed. This assures the Callbox user that the radio has turned on and is ready to transmit their message.</p>
RX Courtesy Beep Enable		<p>In high noise environments it is sometimes difficult to determine when a received message has ended. With the RX Courtesy Beep enabled the Callbox will sound a short beep on the speaker at the end of each received transmission.</p>
TX Time Out Time		<p>Set from the factory for 60 seconds, the TX Time Out Time can be PC programmed for 1-255 seconds. This sets the length of time the Callbox can transmit continuously. If the ON/PTT button is held down longer then the TX Time Out Time will allow, the radio will stop transmitting and a "Busy Signal" will be heard in the speaker until the button is released.</p>
DTMF or Selcall ANI		<p>The RQX can be programmed to send a 3-7 digit DTMF or Selcall ANI code at the beginning of each transmission for radio identification.</p>
Companding	√	<p>The Factory Default setting for Companding is OFF (NOT selected). The radio can be programmed to ENABLE or DISABLE audio companding. Companding will compress transmit audio before sending it, and expand receive audio before it is heard on the speaker to reduce the background noise common in radio communications.</p>

KEY: √ Feature is Field Programmable.

INTERCOM (ALWAYS-ON) PROGRAMMING

The HD-Series Callbox can be Field or PC programmed by the factory or by your Ritron dealer to operate as a two-way intercom. When operating as an intercom the Automatic Turn-Off must be **DISABLED** so that the radio will remain **ON** in a "intercom" mode. The callbox can receive a call from another radio at any time. The higher current requirements of Intercom operation make it undesirable in battery powered only installations. It is recommended you power the callbox using +12 VDC capability.

Required Radio Programming:

Automatic Turn-Off..... (Field or PC Programmable)

This feature must be **DISABLED** via Field or PC programming for the callbox to remain **ON** at all times.

Other Programmable Features to Consider:

Battery Saver (PC Programmable)

Battery Saver can be used to increase battery life in battery powered applications. With Battery Saver enabled, the callbox will periodically "wake-up" and listen for a received signal before returning to a low current "sleep" mode. The Sleep Time can be PC programmed between 0.5 - 8 seconds. A longer sleep time will result in increased battery life, but may result in missed calls.

Busy Channel TX Inhibit..... (Field or PC Programmable)

If **ENABLED** this feature prevents you from talking over someone else on the same channel even if they are using a different tone code. The radio will beep a series of long, low tones that sounds like a "busy signal" when you press the **ON/PTT** button.

FEATURES TO USE WITH INTERCOM (ALWAYS-ON) PROGRAMMING

Programming for Selective Calling:

2-Tone, DTMF or Selcall Paging Decode.....(Field or PC Programmable)

This allows selective calling to a HD-Series Callbox in a radio system where there is more than one Callbox. When the Callbox is programmed for 2-tone, DTMF or Selcall decode in Intercom (Always-On) mode it will sound an alert tone on the Callbox speaker, similar to a telephone ring tone, whenever the 2-tone, DTMF or Selcall page has been successfully decoded. This will alert any users in the immediate area that there is an incoming call on the Callbox.

Ring Tone.....(Field or PC Programmable)

Ring Tone must be set to sound the alert tone on the Callbox speaker when a 2-Tone, DTMF or Selcall Page is successfully decoded. Ring Tone is enabled from the factory.

2-Tone Monitor Trip..... (PC Programmable)

This can be set when used with 2-Tone. DTMF or Selcall decode to allow the Callbox to hear all radio traffic on the channel after it has successfully decoded the correct code, regardless of QC or DQC programming.

- Normal conversation will follow after the 2-tone, DTMF or Selcall code is decoded.
- If the **ON/PTT** button is pressed the Callbox returns to QC or DQC decode operation.
- The radio will automatically reset back to 2-tone, DTMF or Selcall decode after the RQX Reset Time has expired.

Relay Switch Output Programming:

Switch on When Called.....(Field or PC Programmable)

This will close the internal switch output whenever the radio receives a call after an Inactivity Time that exceeds the RQX Reset Time. The switch will remain closed until the **ON/PTT** button is pressed or the RQX Reset Time expires. The switch output could be used to turn on a light or activate an alarm to notify users in the area that an incoming call was present.

RELAY SWITCH OUTPUT OPTIONS (ALLOWS CONTROL OF AN EXTERNAL DEVICE)

(e.g., a gate controller, a strobe light, or any relay controlled device.)

The HD-Series switch output is a simple 3-Amp relay contact closure that can be used to **OPEN** and **CLOSE** a gate, switch on a light, sound an alarm or any other application where remote control of an ON/OFF switch is required. The HD-Series Callbox can be programmed to **OPEN** and **CLOSE** the switch output when one of the following programmed conditions is met.

The HD-Series Callbox can be programmed to alternately **OPEN** and **CLOSE** the switch using a single 2-tone, DTMF or Selcall code, or can be PC programmed for separate **OPEN** and **CLOSE** codes. Field programming offers 3-7 digit DTMF or Selcall codes, or nine 2-tone codes that correspond to field programmable 2-tone codes available in select RITRON portable and base radios.

No Switch(Field or PC Programmable)

Select this option for no switch operation.

Switch On When Called(Field or PC Programmable)

With this option selected the switch will **CLOSE** when the Callbox first receives a call. The switch will remain **CLOSED** until the **ON/PTT** button is pressed or the RQX Reset Time expires. This option is not applicable if the Callbox is programmed for Automatic Turn-Off.

Switch On When Callbox in Use(Field or PC Programmable)

This option will **CLOSE** the switch when the Callbox first sends or receives a call. The switch will remain closed until the RQX Reset Time expires, which also turns the radio off if it is programmed for Automatic Turn-Off.

Switch On When Active with Turn-Off Code(Field or PC Programmable)

This option operates the same as Switch On When Callbox in Use with the added ability to **OPEN** the switch when a unique 2-Tone, DTMF or Selcall Turn-Off Code is received. Unlike the Switch On When Callbox in Use feature, the switch will not **OPEN** when the RQX Reset Time expires unless the Callbox is programmed for Automatic Turn-Off. See 2-TONE, DTMF OR SELCALL DECODE (RECEIVE) SETTINGS on page 29 for details on programming a Turn-Off code.

GateGuard® – Momentary for sec.(Field or PC Programmable)

With this option selected the switch will momentarily **CLOSE** when a unique 2-Tone, DTMF or Selcall code is received. The switch will remain **CLOSED** for the programmed period of time, programmable for 1-255 seconds. See 2-TONE, DTMF OR SELCALL DECODE (RECEIVE) SETTINGS on page 29 for details on programming a 2-Tone, DTMF or Selcall Decode Code.

GateGuard® – Toggle(Field or PC Programmable)

With this option selected the switch will alternately **OPEN** and **CLOSE** when it receives a unique 2-Tone, DTMF or Selcall code. After the code is received the Callbox will transmit a **SINGLE BEEP** if the switch has been **OPENED** and a **DOUBLE BEEP** if the switch has been **CLOSED**. The switch will open when the Callbox turns off if it is programmed for Automatic Turn-Off. See 2-TONE, DTMF OR SELCALL DECODE (RECEIVE) SETTINGS on page 29 for details on programming a 2-Tone, DTMF or Selcall Decode Code.

GateGuard® – On Code / Off Code(Field or PC Programmable)

When this option is selected the switch will **CLOSE** when a unique 2-Tone, DTMF or Selcall code is received, and **OPEN** when a 2-Tone, DTMF or Selcall Turn-Off code is received. The switch will **OPEN** when the Callbox turns off if it is programmed for Automatic Turn-Off. See 2-TONE, DTMF OR SELCALL DECODE (RECEIVE) SETTINGS on page 29 for details on programming a Decode Code and a Turn-Off Code.

2-TONE, DTMF OR SELCALL DECODE (RECEIVE) SETTINGS

With the HD-Series Callbox 2-Tone, DTMF or Selcall decode can be used to selectively call the Callbox in a system where multiple radios operate on a single frequency. Alternatively, 2-Tone, DTMF, or Selcall decode can also be used to operate the Relay Switch Output built into every HD-Series Callbox.

When the radio is programmed for 2-Tone, DTMF or Selcall Paging Decode code, no call will be heard unless the code has been successfully decoded or the **ON/PTT** button has been pressed. After decoding, normal 2-way conversation is possible without the need for the 2-tone, DTMF or Selcall code. Paging Decode is automatically reset when the RQX Reset Time expires.

When the HD-Series Callbox is programmed for switch output or Listen In operation with 2-Tone, DTMF or Selcall decode, regular voice communication is unaffected by the 2-tone, DTMF or Selcall code. If a Relay Switch Output Option is selected that uses 2-tone, DTMF or Selcall decode it cannot be used for Paging Decode.

NOTICE When the callbox is programmed for 2-Tone Decode operation, it is recommended that you do NOT use QC Tone Codes greater than "23" (146.2 Hz).

2-Tone Table # (Field or PC Programmable)

The HD-Series Callbox comes equipped with 9 pre-determined 2-Tone codes that correspond to table codes that certain RITRON portable and base radios can send. Use of the 2-Tone Table codes allows programming without the need for the PC programmer.

1st Tone decoded for **1** sec. (PC Programmable)

You can custom program the 1st tone of the 2-tone code to any frequency between 300-1500 Hz. The 1st tone must be decoded for the programmed period of time before the radio looks for the 2nd tone. The factory setting for decode time is 1 second.

2nd Tone decoded for **1** sec. (PC Programmable)

You can custom program the 2nd tone of the 2-tone code to any frequency between 300-1500 Hz. The 2nd tone must be decoded for the programmed period of time after the 1st tone has been decoded. The factory setting for decode time is 1 second.

All Call decoded for **4** sec. (PC Programmable)

With 2-Tone All Call enabled you can custom program an All Call tone to any frequency between 300-1500 Hz. The All Call tone must be decoded for the programmed period of time. All Call can also be achieved with a unique DTMF or Selcall code. All Call is not enabled as received from the factory.

Ring Tone Enable (Field or PC Programmable)

With this feature enabled the Callbox will sound a ring signal in the speaker, similar to a telephone ring, any time the 2-Tone, DTMF or Selcall code, Group Call or All Call code is decoded. Ring Tone is enabled from the factory.

Transpond Enable (Field or PC Programmable)

Transpond transmits a tone after a 2-Tone, DTMF or Selcall code, Group Call or All Call code has been received to alert the calling radio that the code was successfully decoded. Transpond is enabled from the factory.

Group Call Decode (PC Programmable)

When this option is set, 2-tone decode is achieved if the radio receives the 1st tone for the programmed All Call time. If this option is selected the All Call time must be longer than the 1st Tone time or the Callbox will always decode on the 1st tone, ignoring the 2nd tone altogether. Group Call can also be achieved with a unique DTMF or Selcall code. Group Call is not enabled as received from the factory.

Monitor Trip (PC Programmable)

With this option selected the Callbox will be in carrier squelch mode any time a 2-Tone, DTMF or Selcall code is decoded, regardless of any QC or DQC code programmed in the radio. The radio reverts back to QC or DQC tone decode if the **ON/PTT** button is pressed and reverts back to 2-tone, DTMF or Selcall decode after the RQX Reset Time has expired. Monitor Trip is not enabled from the factory.

2-Tone, DTMF or Selcall Decode with Subtone (Field or PC Programmable)

With 2-Tone, DTMF or Selcall Decode with Subtone enabled, the Callbox will not decode codes unless the correct subtone is also present. 2-Tone, DTMF or Selcall Decode with Subtone is not enabled from the factory.

Turn-Off Code (Field or PC Programmable)

In certain Relay Switch Output applications a separate 2-Tone, DTMF or Selcall Turn-Off Code is required. This code cannot be the same as the 2-Tone, DTMF or Selcall Decode Code.

AUTOMATIC VOICE MESSAGES

The RQX HD-Series Callbox is equipped to use pre-recorded voice messages that notify radio system users when specific events occur. These unique voice messages are recorded and stored on the Callbox, and automatically played back when the associated event occurs. The RQX HD-Series Callbox supports 5 different message events and comes from the factory with no messages recorded.

To activate any of the 5 event messages simply record the voice message per the instructions in this manual. The recorded message can be played back for your review and re-recorded if necessary. You can erase any event message individually if you decide not to utilize that message.

Greeting Message

The Greeting Message is played on the RQX Callbox speaker when the push-to-talk button is first pressed. This message is used to give the Callbox user instruction on how to proceed. A typical message might be *"Welcome to our facility. An attendant will be with you shortly."*

The Greeting Message:

- Is played on the RQX Callbox speaker only when the push-to-talk button is first pressed.
- Will be re-played every time the push-to-talk button is pressed until the Callbox is answered.
- Is not transmitted.
- Can be up to 12 seconds long.

Voice Alert Message

The Voice Alert Message is transmitted automatically by the Callbox when the push-to-talk button is first pressed. Often used with the Call Tone feature, this message alerts radio system users that the Callbox has been activated. Typical messages might be *"South delivery entrance"*, *"Curbside Lane 4"* or *"Main gate"*.

The Voice Alert Message:

- Is transmitted automatically by the Callbox when the push-to-talk button is first pressed.
- Will be re-transmitted every time the push-to-talk button is pressed until the Callbox is answered.
- Is transmitted after the Greeting Message has played on the speaker. If the Greeting Message is not used, the Voice Alert Message will be heard on the speaker.
- Will not be sent if the radio channel is busy when Busy Channel TX Inhibit feature has been enabled. Instead, it will wait for the channel to clear before transmitting.
- Will be automatically re-transmitted periodically until the Callbox is answered if the Callbox has been programmed with the Automatic ID Re-Send feature.
- Will be sent after the Call Tone if the Call Tone feature is enabled.
- Is automatically sent ahead of Sensor Detect or Low Battery/Power Fail messages.
- Can be up to 4 seconds long.

Low Battery/Power Fail Message

The Low Battery/Power Fail Message is automatically transmitted when low voltage is detected on the Callbox.

If the Callbox is programmed with External +12V Power Fail Alert enabled, the Low Battery/Power Fail Message:

- A typical message might be *"Power failure"*
- Will be sent automatically when the loss of the External +V supply voltage is detected.
- Will not be sent if the radio channel is busy, but instead will wait for the channel to clear before transmitting.
- The Voice Alert Message is sent immediately before the Low Battery/Power Fail Message, so a typical transmission might be *"South delivery entrance"* followed by *"Power Failure"*.
- The Call Tone is sent before both messages if the Call Tone feature is enabled.
- Will be sent automatically at the end of any Callbox transmission if a loss of the External +V supply voltage is detected. The message is appended to the existing transmission, and the Call Tone and Voice Alert Message will only be sent if it was a part of the existing transmission.

If the Callbox is programmed with External +12V Power Fail Alert disabled the Low Battery/Power Fail Message:

- A typical message might be *"Low battery"*
- Is NOT sent automatically when the loss of the battery supply voltage is detected.
- Will be sent automatically at the end of any Callbox transmission if low battery voltage is detected. The message is appended to the existing transmission, and the Call Tone and Voice Alert Message will only be sent if it was a part of the existing transmission.

Sensor Detect On Message

The Sensor Detect On Message is automatically transmitted when the Sensor Input is pulled low. Depending on the sensor used, a typical message might be “Door open”, “Motion detected” or “Vehicle present”. The Voice Alert Message is sent immediately before the Sensor Detect On Message, so a typical transmission might be “South delivery entrance” followed by “Door open”.

The Sensor Detect On Message:

- Is automatically transmitted when the Sensor Input is pulled low.
- Will not be sent if the radio channel is busy, but instead will wait for the channel to clear before transmitting.
- Is sent after the Call Tone and the Voice Alert Message if the radio is programmed for those features.
- Can be up to 4 seconds long.

Sensor Detect Off Message

The Sensor Detect Off Message is automatically transmitted when the Sensor Input is pulled high. Depending on the sensor used, a typical message might be “Door closed”, “Motion detected” or “Vehicle present”. The Voice Alert Message is sent immediately before the Sensor Detect Off Message, so a typical transmission might be “South delivery entrance” followed by “Door closed”.

The Sensor Detect Off Message:

- Is automatically transmitted when the Sensor Input is pulled high.
- Will not be sent if the radio channel is busy, but instead will wait for the channel to clear before transmitting.
- Is sent after the Call Tone and the Voice Alert Message if the radio is programmed for those features.
- Can be up to 4 seconds long.

AUTOMATIC ID RE-SEND.....

The RQX HD-Series Callbox can automatically re-send the Call Tone, Voice Alert Message, and DTMF or Selcall ANI a programmed number of times when a call is not immediately answered. This allows the Callbox to periodically repeat the Voice Alert Message without further input from the Callbox user. The periodic rate is determined by the RQX Reset Time.

Following is an example of Automatic ID Re-Send programming and its effect:

The Callbox is field programmed for:

- Greeting Message “Welcome to Ritron, someone will be with you shortly”
- Voice Alert Message “Main Entrance”
- Call Tone ON
- Automatic Turn-Off enabled
- RQX Reset Time of 20 seconds
- Automatic ID Re-Send set to 1

Here is how it will operate:

- A guest presses the Callbox On/PTT button and the Greeting Message “Welcome to Ritron, someone will be with you shortly” is heard on the Callbox speaker.
- If the radio channel is not being used the Callbox will transmit the Call Tone, followed by the Voice Alert Message “Main Entrance.” This will be heard by all system radio users, but not heard on the Callbox speaker.
- If the Callbox is not answered within 20 seconds (RQX Reset Time) the Call Tone and Voice Alert Message will be re-transmitted (Automatic ID Re-Send).
- If the Callbox is again not answered within 20 seconds (RQX Reset Time) it will turn off (if Automatic Turn-Off is enabled).
- If the Callbox On/PTT button is pressed again at any time before it is answered the entire process described above is re-started.
- If the Callbox is answered before it automatically turns off the Callbox operates as normal 2-way radio communication with no messages or Call Tone.









Using Automatic ID Re-Send to Extend RQX Reset Time

A Voice Alert Message does not have to be used to enjoy the benefits of Automatic ID Re-Send. This feature can also be used to extend the RQX Reset Time whenever the Callbox On/PTT button is 1st pressed, providing radio users additional time to respond to the Callbox.

For example, if the Callbox is programmed for an RQX Reset Time of 10 seconds and Automatic ID Re-Send of 5, the Callbox will remain ON for 60 seconds (RQX Reset Time plus RQX Reset Time multiplied by number of Automatic ID Re-Send) after the On/PTT button is 1st pressed instead of 10 seconds (RQX Reset Time). Once the Callbox has been answered it will turn off after 10 seconds (RQX Reset Time) of inactivity.

HOW TO RECORD A VOICE MESSAGE

Recite your voice message a number of times before recording to be sure it can be completed in the time allowed. For best results speak directly into the Callbox microphone in a slow, clear voice.

- | | |
|---|--|
| 32 | <ol style="list-style-type: none"> 1. Refer to Table 5 to determine the two-digit Record Code and write it down. |
| | <ol style="list-style-type: none"> 2. Using the T-25 Torx bit included with the radio, loosen the two captured Torx screws on the front of the hinged HD case and open. |
| | <ol style="list-style-type: none"> 3. Leave the batteries connected to the radio. Make sure the unit has batteries installed.
NOTE: The voltage of the batteries must be greater than 6 VDC to program properly. |
| | <ol style="list-style-type: none"> 4. Press and release the ON/PTT button on the front of the unit to turn the radio on. |
|  | <ol style="list-style-type: none"> 5. Press and HOLD the Program Button (See FIG-2 on page 8 for location). A "P" will appear on the program display as you enter program mode and the radio will beep rapidly. |
|  | <ol style="list-style-type: none"> 6. Release the program button after the beeping has stopped. The radio will emit a triple beep indicating that the radio is in program mode and a hyphen will appear on the program display. |
|  | <ol style="list-style-type: none"> 7. Click the Program button until the program display shows the Program Code "A". Pause—the radio will sound a low tone and show a hyphen across the center of the display to indicate that it is ready to accept a 2-digit Record Voice Message Code. |
| <div style="display: flex; align-items: center;"> <div style="writing-mode: vertical-rl; transform: rotate(180deg); font-size: 8px; margin-right: 5px;">VOICE MESSAGE CODE</div> <div style="display: flex; gap: 5px;">   </div> </div> | <ol style="list-style-type: none"> 8. Enter the 1st digit of the Record Code by clicking the Program button until the program display shows the desired number. Pause—the radio will sound a low tone and show a hyphen across the center of the display to indicate that it is ready to accept the next digit. |
| <div style="display: flex; align-items: center;"> <div style="writing-mode: vertical-rl; transform: rotate(180deg); font-size: 8px; margin-right: 5px;">VOICE MESSAGE CODE</div> <div style="display: flex; gap: 5px;">   </div> </div> | <ol style="list-style-type: none"> 9. Enter the 2nd digit of the Record Code by clicking the Program button until the program display shows the desired number. Pause—the radio sounds a low tone and will show a hyphen across the center of the display to indicate that it is ready to accept the next digit. |
| | <ol style="list-style-type: none"> 10. Press and release the ON/PTT button to save the 2-digit Record Voice Message Code and initiate the voice record process. |
|  | <p>NOTE: An error tone will sound if you attempt to enter an incorrect code, an "E" will appear on the display. Check the digits you are attempting to enter, then re-enter.</p> |
| | <ol style="list-style-type: none"> 11. Press and Hold the Program Button and wait for the "Clear to Talk" beep. Speak directly into the Callbox microphone in a slow, clear voice. |
|  | <ol style="list-style-type: none"> 12. Release the Program Button button when you have completed the message. A triple beep will sound to indicate that recording was successful and a hyphen will appear on the program display. The radio is now ready to record another message, or for another program entry. |
| | <ol style="list-style-type: none"> 13. Once you have recorded your final message, press the ON/PTT button a final time to turn the radio off. Turn the radio back on for normal operation. |

HOW TO RECORD A VOICE MESSAGE USING .WAV AUDIO FILES

The Ritron HD-Series Callbox is capable of recording audio signals from the sound card output of your PC. Using Ritron programmer RQX-PCPS you can play a pre-recorded .wav sound file on your computer, apply the computer's audio output to the HD-Series Callbox, and record it into the radio.

IMPORTANT

The HD-Series Callbox does **NOT** allow you to "download" the .wav audio file directly into the radio via USB. The .wav file must be played on the computer with its audio output applying the audio signal to the radio.

STEP-BY-STEP INSTRUCTIONS:

Before you begin, be sure the radio has been completely programmed to your desired, final configuration.

1. Connect the computer audio output to the HD-Series Callbox

This will typically be a 3.5mm stereo jack on the back or side of your computer marked as AUDIO OUT. This output is where you might connect desktop speakers or headset. The computer audio is connected to the HD-Series Record Audio Input via 2-pin header P303 shown below, located directly above the Program Display. A 3.5mm to 2-pin audio cable (60201123) is available from Ritron for connecting to the computer. If you choose to create your own cable, a 2-pin mating connector is available from Ritron (2142D020) with a 6" wire length.

Negative (Gnd) Black
Positive (Audio) Red

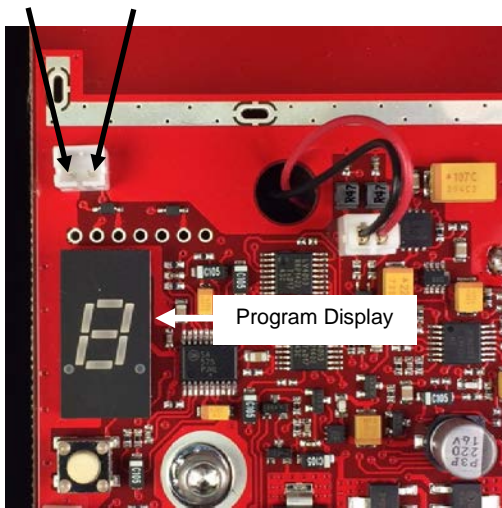

When removing the 2-pin connector from P303 Record Audio Input grasp and pull the connector housing. Do **NOT** remove by pulling on the wires as damage may result.

2. Connect the USB programming cable from the computer to the HD-Series Callbox and read the radio programming using the Ritron RQX-PCPS Programmer.

Consult the RQX-PCPS User Manual for detailed information on programming the radio.

3. Using the Ritron RQX-PCPS Programmer, select the message you would like to record.

a. Set Record Mode to .wav file.

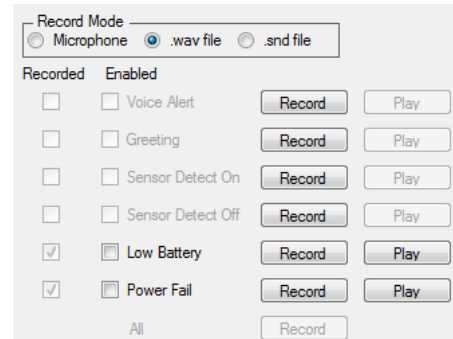

b. Press the **Record** button for the desired message. A .wav Record screen will appear as shown below.

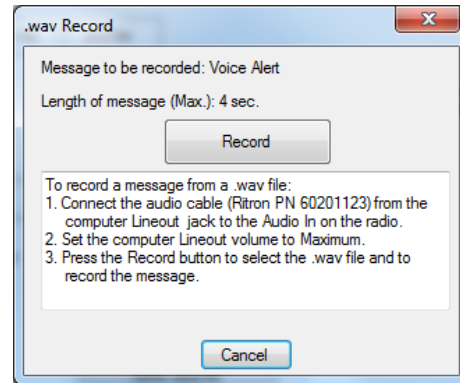

- c. Press the **Record** button on the .wav Record screen to select the .wav file to be recorded.
- d. Using standard Windows navigation, select the .wav file to be recorded and press the **Open** button.
- e. The programmer will place the radio into record mode and record the selected .wav file.

4. Press the **Play button to hear the recorded message played on the HD-Series speaker.**









To hear the message be sure the HD-Series speaker is connected.

Adjusting the audio output level from a PC

The overall sound quality of the message will depend on the quality of the recorded message. Because the recording of .wav files does not engage automatic gain control, it is imperative that the signal level of the audio presented to the input of the recording circuit be optimal. This can be achieved by opening the SOUND PROPERTIES applet from the CONTROL PANEL of your PC. If using test equipment to check the signal level, a 1V P-P signal measured at P303 is recommended. If test equipment is unavailable, a simple trial and error approach can be used to achieve the best sound quality of the recorded message.

HOW TO PLAY A VOICE MESSAGE

Recorded voice messages can be played back on the Callbox speaker for review.

- | | |
|---|---|
| 42 | <ol style="list-style-type: none"> 1. Refer to Table 5 to determine the two-digit Play Code and write it down. 2. Using the T-25 Torx bit included with the radio, loosen the two captured Torx screws on the front of the hinged HD case and open. 3. Leave the batteries connected to the radio. Make sure the unit has batteries installed.
NOTE: The voltage of the batteries must be greater than 6 VDC to program properly. 4. Press and release the ON/PTT button on the front of the unit to turn the radio on. |
|  | <ol style="list-style-type: none"> 5. Press and HOLD the Program Button (See FIG-2 for location). A "P" will appear on the program display as you enter program mode and the radio will beep rapidly. |
|  | <ol style="list-style-type: none"> 6. Release the program button after the beeping has stopped. The radio will emit a triple beep indicating that the radio is in program mode and a hyphen will appear on the program display. |
|  | <ol style="list-style-type: none"> 7. Click the Program button until the program display shows the Program Code "A". Pause—the radio will sound a low tone and show a hyphen across the center of the display to indicate that it is ready to accept a 2-digit Play Recorded Message Code. |
| <div style="display: flex; align-items: center;"> <div style="writing-mode: vertical-rl; transform: rotate(180deg); font-size: 8px; margin-right: 5px;">VOICE MESSAGE CODE</div> <div style="margin-right: 5px;">{</div> <div style="display: flex; flex-direction: column; gap: 5px;">   </div> </div> | <ol style="list-style-type: none"> 8. Enter the 1st digit of the Play Code by clicking the Program button until the program display shows the desired number. Pause—the radio will sound a low tone and show a hyphen across the center of the display to indicate that it is ready to accept the next digit. |
| <div style="display: flex; align-items: center;"> <div style="writing-mode: vertical-rl; transform: rotate(180deg); font-size: 8px; margin-right: 5px;">VOICE MESSAGE CODE</div> <div style="margin-right: 5px;">{</div> <div style="display: flex; flex-direction: column; gap: 5px;">   </div> </div> | <ol style="list-style-type: none"> 9. Enter the 2nd digit of the Play Code by clicking the Program button until the program display shows the desired number. Pause—the radio sounds a low tone and will show a hyphen across the center of the display to indicate that it is ready to accept the next digit. |
|  | <ol style="list-style-type: none"> 10. Press and release the ON/PTT button to begin playback of the message. If the message has not been recorded an error tone will sound and an "E" will appear on the display. <p>NOTE: An error tone will sound if you attempt to enter an incorrect code, an "E" will appear on the display. Check the digits you are attempting to enter, then re-enter.</p> |
|  | <ol style="list-style-type: none"> 11. Once the message playback is complete a triple beep will sound and a hyphen will appear on the program display. The radio is now ready to playback another message, or for another program entry. |
| | <ol style="list-style-type: none"> 12. Once you have played your final message, press the ON/PTT button a final time to turn the radio off. Turn the radio back on for normal operation. |

HOW TO ERASE A VOICE MESSAGE

If you decide not to use a voice message that is already recorded, it can be easily erased via field programming. Follow the "How to Play a Voice Message" instructions above using the Erase Code specified in [Table 5](#).

CONFIGURING THE CALLBOX FOR A GATEGUARD® APPLICATION.....

The HD-Series Callbox can be mounted to virtually any surface with four (4) ¼” panhead screws. Choose a type of screw thread and screw length which will hold firmly in the surface to which the unit will be mounted.

Mounting the HD-Series Callbox:

1.  The Ritron HD Accessory Cable is included with each HD-Series callbox. Due to the wide variety of installation possibilities, RITRON does not install the cable required to bring external connections into the Callbox. Refer to the CONNECTING TO THE HD ACCESSORY CABLE section on page 9 for details.
2. Install the 4 mounting brackets to the back of the Callbox case. The mounting brackets can be installed vertically, as shown, or horizontally. As an alternative, optional mounting bracket RQX-HDMK provides easy mounting to a gooseneck pedestal.
3. **CONNECTING THE RELAY SWITCH OUTPUTS TO AN EXTERNAL DEVICE**
 - a. Following the directions in CONNECTING TO THE HD ACCESSORY CABLE section on page 9, thread the cable from the external device you wish to control through the Heyco® Cordgrip with approximately 6 inches of cable inside the HD-Series case.
 - b. Your external cable will be connected to the Callbox HD Accessory Cable with wirenuts, dress your external wires accordingly (Refer to Table 7).
 - c. Following the directions in CONNECTING TO THE HD ACCESSORY CABLE section on page 9, secure the cable to ensure moisture and vandal resistant functions to the HD-Series Callbox case.
 - Consult the manufacturer of the external device you are attempting to control for the recommended wire gauge.
 - Confirm that your application will NOT exceed the maximum rating of the on-board relay of 120 VAC @ 3 amp.
 - Make sure all power to the equipment is turned OFF or disconnected.

 **CAUTION:** The HD Accessory Cable and wirenuts are to be positioned at the bottom of the case, away from the internal antenna.

4. Position the HD-Series Callbox case in the chosen installation location and secure it in place with four screws through the mounting brackets.

TABLE 7: HD ACCESSORY CABLE

<u>Pin #</u>	<u>Wire Color</u>	<u>Description</u>
6	Red	External 12 VDC + input
5	Black	External 12 VDC - input
4	Blue	Relay Switch Output + connection
3	Green	Relay Switch Output - connection
2	White	Sensor Input + connection
1	Brown	Sensor Input - ground

HOW TO FIELD PROGRAM THE HD-SERIES CALLBOX FOR GATEGUARD® OPERATION

The HD-Series Callbox can be field programmed for basic GateGuard® operation, or PC programmed to suit your unique requirements. **The instructions in this section apply only to Field Programmable features.** If PC programming software has been used to set 2-Tone, DTMF or Selcall decode (receive) or other optional GateGuard® features, operation may not be as described here.

Follow these steps to program the HD-Series Callbox for GateGuard® operation:

1. Program the **frequency and tone codes** per the HOW TO FIELD PROGRAM FREQUENCY & TONE CODES on page 14 for instructions.
2. Program the **2-Tone, DTMF or Selcall Decode (Receive) code** per the HOW TO FIELD PROGRAM 2-TONE, DTMF OR SELCALL DECODE (RECEIVE) OPERATION on page 17 for instructions.
3. Program the callbox for **GateGuard® Momentary Operation** per the HOW TO FIELD PROGRAM 2-TONE, DTMF OR SELCALL DECODE (RECEIVE) OPERATION on page 17 for instructions.

The HD-Series Callbox will now operate in GateGuard® mode as follows:

- The Callbox will be in “**Automatic Turn-Off**” mode. The **ON/PTT** button must first be pressed as described in “OPERATING THE HD-SERIES CALLBOX WITH FACTORY DEFAULT SETTINGS” section before normal two-way communications can be established.
- If the Callbox does not send or receive a signal for more than 10 seconds the Callbox will automatically turn off. The **ON/PTT** button must be pressed to turn the Callbox back on and receive a call.
- When the Callbox receives and decodes the correct 2-Tone, DTMF or Selcall Decode code the Callbox Relay Switch Output will momentarily **CLOSE** the switch for 1 second. The Callbox will also automatically transmit a confirmation tone back to the senders radio notifying them that the correct 2-tone, DTMF or Selcall code has been decoded at the HD-Series Callbox.

OPTIONAL GATEGUARD® SETTING/FEATURES

The HD-Series Callbox can be Field Programmed, or PC programmed using special software, for customized GateGuard® applications.

Automatic Turn-Off.....(Field or PC Programmable)

This is **ENABLED** as the Factory Default setting. The callbox will turn **OFF** when the RQX Reset Time has expired. The Reset Time is a pre-programmed amount of time of “no activity” (no calls transmitted, no calls received) before the callbox turns **OFF** in order to conserve battery life. The callbox can be turned back **ON** when the **ON/PTT** button is pressed. This is the recommended mode of operation for all battery only powered applications.

If Automatic Turn-Off is **NOT** selected the callbox does **NOT** completely turn **OFF**, but remains in the Intercom mode, allowing the callbox to receive calls at any time.

Operating the callbox with Automatic Turn-Off **DISABLED** significantly increases battery drain, and is therefore **NOT** recommended for battery only powered applications. Battery life can be increased using the Battery Saver Enable feature detailed in this section.

RQX Reset Time.....(Field or PC Programmable)

This is set from the factory for 10 seconds, but can be Field Programmed to 9 different times ranging from 5 seconds to 4 minutes, and PC programmed for 5-255 seconds. A shorter RQX Reset Time will result in increased battery life. In standard Automatic Turn-Off operation a longer inactivity timer will allow more time for a response before the callbox turns **OFF**.

Battery Saver Enable.....(PC Programmable)

When the HD-Series Callbox is programmed to operate with Automatic Turn-Off **DISABLED**, Battery Saver can increase battery life in both internal or external battery powered applications.

With Battery Saver Enable, the callbox will periodically Wake-Up and listen for a received signal before returning to a low current Sleep mode. The sleep time can be PC programmed between 0.5 - 8 seconds with the Battery Saver Sleep Time setting. A longer sleep time will result in increased battery life, but may result in missed calls.

The callbox immediately leaves Battery Saver mode any time the **ON/PTT** Button is pressed or a signal is received, and will not return to Battery Saver until the period of no activity exceeds the RQX Reset Time.

OPTIONAL GATEGUARD® SETTING/FEATURES (CONTINUED)

External +12 VDC Power Fail Alert Tone(PC or Field Programmable)

By selecting the +12 VDC Power Fail Alert Tone feature the callbox will look for a loss of the +12 VDC power source. The callbox will immediately transmit an Alert Tone to notify personnel that the +12 VDC source has been lost and is now operating on battery back-up. The callbox will transmit an Alert Tone once every hour until the +12 VDC power source is restored or until the back-up batteries are exhausted. Even if this feature is **NOT** selected, it will always revert to Back-up Battery power, see page 5 for details.

NOTE: In applications where external power is available, we recommend using the RPS-EXPO Cube Power Supply. See page 5 for details.

Send Call Tone.....(Field or PC Programmable)

The Factory Default setting has the Call Tone feature **ON** (refer to HOW TO FIELD PROGRAM FEATURE CODES on page 22). The callbox can be programmed to transmit a Call Tone if the Reset Time has expired and the **ON/PTT** button is pressed. This will alert system users that the call is originating from the callbox.

Ring Tone.....(Field or PC Programmable)

This will sound an alert tone on the callbox speaker, similar to a telephone ring tone, whenever the correct 2-Tone, DTMF or Selcall code has been successfully decoded. This feature is used to alert the Callbox user that the gate is being **opened** or **closed**. Ring Tone is enabled from the factory.

GateGuard® – Toggle(Field or PC Programmable)

Will alternately open and close the Relay Switch Output when it receives a unique 2-Tone, DTMF or Selcall code. After the 2-tone decode (receive) code is received the callbox will transmit a single beep if the switch has been **opened** and a double beep if the switch has been **closed**. The switch will open when the callbox turns off if it is programmed for Automatic Turn-Off.

GateGuard® On Code / Off Code(Field or PC Programmable)

This operation allows programming of separate **ON** and **OFF** 2-Tone, DTMF or Selcall Decode (receive) codes. The HD-Series Callbox will **CLOSE** the Relay Switch Output upon receiving the **ON** code, and **OPEN** the Relay Switch Output upon receiving the **OFF** code.

When reading out the 2-Tone, DTMF or Selcall programming as described in the TABLE 5: ADVANCED FEATURE CODES, PROGRAMMING READOUT CODES section on page 24, the **ON** code will be displayed.

Relay Polarity

The Relay Switch Output can be set for a normally-open or normally-closed condition depending on the position of the Relay Polarity Jumper. (See FIG-1)

Sensor/Contact Closure Input

The Sensor Input will detect a logic level and transmit an Alert tone when a change in logic level is detected. Separate alert tones are used for **OPEN** (logic level high) tone and **CLOSED** (logic level low) tone. Additionally, the Sensor Input can be used to turn on the RQX Callbox with the Sensor Input Jumper in place.

Busy Channel TX Inhibit(Field or PC Programmable)

This will not allow you to transmit when another user is already transmitting on your radio frequency, even if they are using a different tone code. The radio will beep a series of long, low tones (like a busy signal) while the **ON/PTT** button is held down.

FCC Licensing

Except for the five (5) MURS frequencies listed on page 14, the FCC requires the owners of radios operating on these frequencies to obtain a station license before using them.

The station licensee is responsible for ensuring that transmitter power, frequency and deviation are within the limits specified by the station license. The station licensee is also responsible for proper operation and maintenance of the radio equipment. This includes checking the transmitter frequency and deviation periodically, using appropriate methods.

To get an FCC license for VHF or UHF frequencies, submit FCC application Form 601. Your Ritron dealer can help you with this process.

How to Obtain an FCC Radio License

Because your Ritron radio operates on Private Land Mobile frequencies, it is subject to the Rules and Regulations of the FCC, which requires all operators of these frequencies to obtain a station license before operating their equipment. Make application for your FCC license on FCC Forms 601, Schedules D and H, and Fee Remittance Form 159.

To have forms and instructions faxed to you by the FCC, call the FCC Fax-On-Demand system at **202-418-0177** from your fax machine; request Document numbers 3000159, 3060001, 3060003, and 3060006.

To have Document numbers 3000159, 3060001, 3060003, and 3060006 mailed to you, call the FCC Forms Hotline at **800-418-FORM (800-418-3676)**.

For help with questions concerning the license application, contact the FCC at **888-CALL-FCC (888-225-5322)** or log on at www.fcc.gov

You must decide which radio frequency(ies) you can operate on before filling out your application.

For help determining your frequencies, call Ritron at **800-USA-1-USA (800-872-1872)**.

INDUSTRY CANADA Regulations

Industry Canada requires the owners of the radios to obtain a radio license before using them.

Application forms can be obtained from the nearest Industry Canada District office.

1. Fill in the items per the instructions. If you need additional space for any item, use the reverse side of the application.
2. Use a typewriter or print legibly.
3. Make a copy for your files.
4. Prepare a check or money order to "Receiver General for Canada", for the amount listed at <http://www.ic.gc.ca/eic/site/smt-gst.nsf/eng/sf01027.html>. (Licenses are renewed annually on April 1st. Refer to the calculation for application fees for each month.)
5. Mail the completed application, along with your check or money order, to the closest Industry Canada District Office.

Notes: Fees are subject to change without notice.

Safety Standards

The FCC (with its action in General Docket 79-144, March 13, 1985) has adopted a safety standard for human exposure to radio frequency electromagnetic energy emitted by FCC regulated equipment. Ritron observes these guidelines and recommends that you do also:

- DO NOT hold the radio so that the antenna is very close to or touching exposed parts of the body, especially the face or eyes, while transmitting. Keep the radio vertical, eight inches away while talking into the front panel.
- DO NOT press the Push-To-Talk except when you intend to transmit.
- DO NOT operate radio equipment near electrical blasting caps or in an explosive atmosphere.
- DO NOT allow children to play with any radio equipment that contains a transmitting device.
- Repair of Ritron products should be performed only by Ritron authorized personnel.

Service

Federal law prohibits you from making any internal adjustments to the transmitter, and / or from changing transmit frequencies unless you are specifically designated by the licensee.

If your radio equipment fails to operate properly, or you wish to have the radio programmed, contact your local authorized dealer or Ritron.

U.S. Manufacturer:

RITRON, INC. - Repair Department

505 West Carmel Drive,

Carmel, Indiana 46032 USA

Phone: 317-846-1201

FAX: 317-846-4978

Email: customer_service@ritron.com

RITRON, INC. LIMITED WARRANTY

WHAT THIS WARRANTY COVERS:

RITRON, INC. ("RITRON") provides the following warranty against defects in materials and/or workmanship in **RITRON Radios and Accessories** under normal use and service during the applicable warranty period (as stated below). "Accessories" means antennas, holsters, chargers, ear-phones, speaker/microphones and items contained in the programming and programming/service kits.

<u>WHAT IS COVERED</u>	<u>FOR HOW LONG</u>	<u>WHAT RITRON WILL DO</u>
HD-Series Callbox	1 year*	During the first year after date of purchase, RITRON will repair or replace the defective product, at RITRON's option, parts and labor included at no charge.
Accessories	90 days*	*After date of purchase

WHAT THIS WARRANTY DOES NOT COVER:

- Any technical information provided with the covered product or any other RITRON products;
- Installation, maintenance or service of the product, unless this is covered by a separate written agreement with RITRON;
- Any products not furnished by RITRON which are attached or used with the covered product, or defects or damage from the use of the covered product with equipment that is not covered (such as defects or damage from the charging or use of batteries other than with covered product);
- Defects or damage, including broken antennas, resulting from:
 - misuse, abuse, improper maintenance, alteration, modification, neglect, accident or act of God,
 - the use of covered products other than in normal and customary manner or,
 - improper testing or installation;
- Defects or damages from unauthorized disassembly, repair or modification, or where unauthorized disassembly, repair or modification prevents inspection and testing necessary to validate warranty claims;
- Defects or damages in which the serial number has been removed, altered or defaced.
- Batteries if any of the seals are not intact.

IMPORTANT: This warranty sets forth the full extent of RITRON's express responsibilities regarding the covered products, and is given in lieu of all other express warranties. What RITRON has agreed to do above is your sole and exclusive remedy. No person is authorized to make any other warranty to you on behalf of RITRON. Warranties implied by state law, such as implied warranties of merchantability and fitness for a particular purpose, are limited to the duration of this limited warranty as it applies to the covered product. Incidental and consequential damages are not recoverable under this warranty (this includes loss of use or time, inconvenience, business interruption, commercial loss, lost profits or savings). Some states do not allow the exclusion or limitation of incidental or consequential damages, or limitation on how long an implied warranty lasts, so the above limitations or exclusions may not apply to you. Because each covered product system is unique, RITRON disclaims liability for range, coverage, or operation of the system as a whole under this warranty.

WHO IS COVERED BY THIS WARRANTY: This warranty is given only to the purchaser or lessee of covered products when acquired for use, not resale. This warranty is not assignable or transferable.

HOW TO GET WARRANTY SERVICE: To receive warranty service, you must deliver or send the defective product, delivery costs and insurance prepaid, within the applicable warranty period, to **RITRON, INC., 505 West Carmel Drive, Carmel, Indiana 46032, Attention: Warranty Department**. Please point out the nature of the defect in as much detail as you can. You must retain your sales or lease receipt (or other written evidence of the date of purchase) and deliver it along with the product. If RITRON chooses to repair or replace a defective product, RITRON may replace the product or any part or component with reconditioned product, parts or components. Replacements are covered for the balance of the original applicable warranty period. All replaced covered products, parts or components become RITRON's property.

RIGHTS TO SOFTWARE RETAINED : Title and all rights or licenses to patents, copyrights, trademarks and trade secrets in any RITRON software contained in covered products are and shall remain in RITRON. RITRON nevertheless grants you a limited non-exclusive, transferable right to use the RITRON software only in conjunction with covered products. No other license or right to the RITRON software is granted or permitted.

YOUR RIGHTS UNDER STATE LAW: This warranty gives you specific legal rights, and you may also have other rights which vary from state to state.

WHERE THIS WARRANTY IS VALID: This warranty is valid only within the United States, the District of Columbia and Puerto Rico.