



## LPA SERIES, RADIO TO INTERCOM INTERFACE



### Updated:

- **Analog Technology**
- **Compatible with VHF/UHF LMR Business Band, VHF MURS and FRS 2-Way Radios**
- **Compatibility with 2013 FCC Narrowband Radios**
- **Relay Switch Closure on Receive**
- **Record and Play Message DELAY Feature**
- **Record and Play Message REPEAT Feature**

# LPA-Series Owner's Manual



Ritron Pub. 14500062

Rev. D

08/18

© 2018 Ritron, Inc. All rights reserved. Ritron, Patriot, Jobcom, OutPost, GateGuard, Quiet Call and Quick Assist are registered trademarks of Ritron, Inc. Loudmouth, Quick Talk, Liberty and RadioNexus are trademarks of Ritron, Inc.

**Call 800-USA-1-USA**

For the right Wireless Solutions for your communication needs.

P.O. Box 1998 · Carmel, Indiana 46082-1998 · 317-846-1201 · Fax: 317-846-4978

Email: [ritron@ritron.com](mailto:ritron@ritron.com) · [www.ritron.com](http://www.ritron.com)

# Table of Contents

## 1 Getting Started

1.1	Overview .....	1
1.2	LPA-Series receiver assembly.....	2
1.3	Paging the LPA-Series receiver.....	3
1.4	Compatibility with other RITRON model radios .....	4

## 2 Installation

2.1	Radio coverage site survey .....	5
2.2	LPA-Series radio receiver installation.....	8
2.3	LPA-Series AUX IN installation.....	9
2.4	LPA-Series 600Ω BALANCED installation.....	10
2.5	LPA-Series RELAY installation.....	11

## 3 Programming

3.1	LPA-Series Field Programming Overview .....	12
3.2	Readout Current Frequency, Tone and Selective Signaling Codes.....	13
3.3	Program Frequency & Tone Codes .....	14
	<b>Table 1:</b> Programmable Frequency Codes .....	15
	<b>Table 2:</b> Interference Eliminator Programmable QC Tone Codes.....	15
	<b>Table 3:</b> Digital Interference Eliminator Programmable DQC Tone Codes .....	15
3.4	Program Paging Codes .....	16
	<b>Table 4:</b> 2-Tone Paging Codes .....	16
3.5	Program LPA-Series Features.....	17
	<b>Table 5:</b> Feature Codes .....	18
3.6	Program LPA-Series Volume.....	19
	Checking the current volume setting .....	19
3.7	Program the NOAA Weather Frequency .....	20
	<b>Table 6:</b> NOAA Weather Frequency Codes .....	20
3.8	Field Programming Flow Chart.....	21

## 4 Operation

4.1	Basic Operation .....	22
4.2	Selcall Paging.....	22
4.3	2-Tone Paging.....	23
4.4	Record and Play.....	23
4.5	Weather Alert.....	24
4.6	Battery Powered Operation .....	24
4.7	Relay Operation.....	24
4.8	LPA-Series Options .....	25
4.9	How to Minimize Feedback.....	25

## 5 Specifications

5.1	General.....	26
5.2	RPS-1B Power Cube.....	26
5.3	LPA-Series Receiver .....	27

6	Warranty .....	28
---	----------------	----

# 1

## Getting Started

The LPA-Series receiver is designed for interface to existing wired Public Address systems to allow PA announcements using VHF or UHF business band, FRS, or MURS radios.

### 1.1 Overview

The LPA receiver allows all the wired speakers in a PA/Intercom system immediately accessible via a 2-way radio/base station/etc. The LPA receiver can be connected to an existing wired system. An LM and LPA receiver system can be used side-by-side on the same frequency.

#### What is the difference between the LM-V150/U450 receiver and the LPA-V150/U450 receiver?

- The LM Receiver (#LM-V150/U450) has a built-in audio amplifier. The built-in audio amplifier allows the LM receiver by itself to drive up to 2 Ritron PA horn speakers. The LM receiver and included PA Horn speaker is what we call a stand-alone wireless PA system.
- The LPA Receiver (#LPA-V150/U450) does not have a built-in PA amplifier. The LPA receiver is designed to be connected to an existing PA/intercom system with its own PA amplifier and wired speakers.
- The LPA Receiver does not include a back-up battery since it is merely a component of a larger system usually powered by AC and its own battery back-up system.

#### Features and Benefits

- Available in VHF (150-162 MHz) and UHF (450-470MHz) frequency bands. Provides compatibility with business band 2-way radios, License-FREE VHF business band radios (MURS), Family Radio Service and GMRS radios.
- Provides interconnection to the Public Address amplifier through a high impedance, unbalanced AUX input **OR** a 600Ω, balanced MIC input. Allows personnel to remain mobile while providing access via 2-way radio access to existing PA speakers located throughout the facility.
- "Record and Play" allows use of radios in close proximity to PA speakers without feedback. The LPA-Series records/buffers received messages up to 30 seconds in length, then plays them over the PA immediately after releasing the PTT button on the radio.
- Provides a relay switch closure whenever the LPA receives a valid incoming message.
- Programmable volume control adjusts audio output level 5-99%. Allows custom adjustment for most applications.
- Easy "Plug and Play" installation.
- Selective signaling includes QC, DQC, Selcall, 2-Tone to provide an added layer of access control to the PA system.
- Pre-announce tone (similar to existing PA systems) with programmable on/off and volume level.
- NOAA Weather Alert (VHF only).
- Field or PC programmable to frequencies within the respective band (i.e. 150-165 MHz, 450-470 MHz).
- The LPA-Series is for interface only to an existing PA system, it cannot drive a loudspeaker by itself.
- The LPA-Series is for indoor use ONLY.

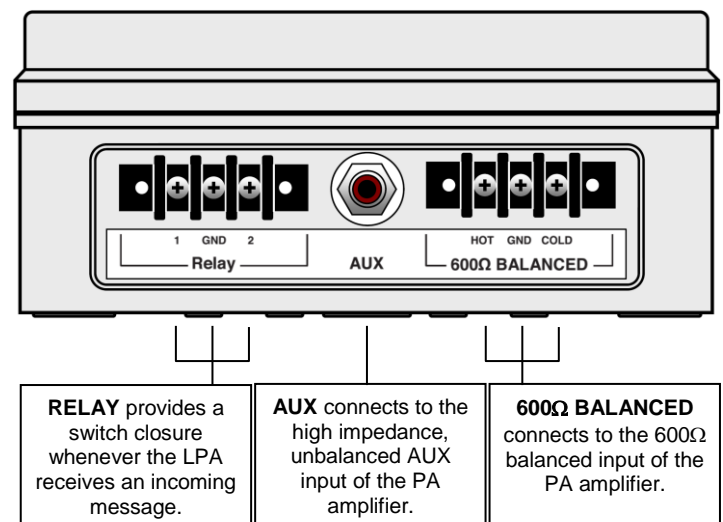

## 1.2 LPA-Series receiver assembly

The LPA-Series receiver is on any time power is applied. The receiver case must be opened to install the Mounting Bracket or to program the LPA-Series receiver.

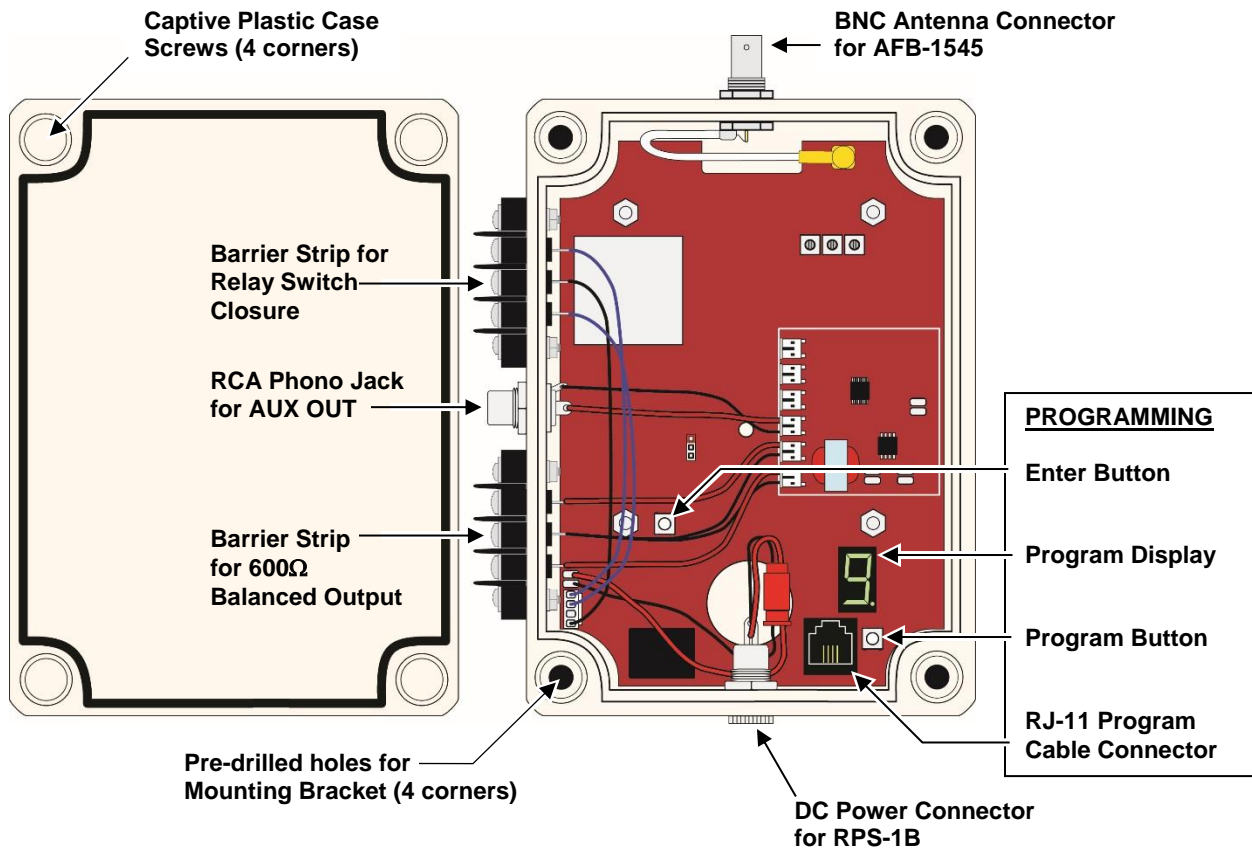

1. Loosen the (4) captive screws in the front corners of the case. These screws are captive to the housing; to prevent damaging them, **DO NOT** remove the screws from the housing.
2. Separate the case front from the case back.
3. **Install the Mounting Brackets** by inserting the 4 sealed screws included in the Mounting Bracket kit into the 4 pre-drilled holes shown above. Secure the Mounting Brackets to the case using the lockwashers and nuts included in the Mounting Bracket kit.
4. **Program the LPA-Series receiver** per the instructions in the Programming section of this manual, leaving the RPS-1B power supply connected to the radio. Press the **Enter** button twice before re-assembling the case to be sure the LPA-Series receiver is reset and ready for operation.
5. Carefully position the case front onto the case back. Secure the case halves by tightening the 4 captive screws in the front corners of the case.

## 1.3 Paging the LPA-Series receiver

The LPA-Series receiver can be paged with 2-way radios programmed for Quiet Call (CTCSS), Digital Quiet Call (DCS), 2-Tone Paging, or Selcall paging formats. Each format offers a unique method of paging the LPA receiver.

Refer to the Programming section of this manual for specific instructions on programming your LPA receiver to one of these selective signaling formats.

**Ritron strongly recommends operation of the LPA-Series receiver with one of the following selective signaling formats enabled.**

### **Paging the LPA-Series receiver with Quiet Call (CTCSS) only:**

- To page the LPA receiver a user simply presses the 2-way radio's PTT and speaks while on the LPA channel.
- Your 2-way radio must be programmed for a channel dedicated to LPA receiver operation. Only those radios programmed with the LPA channel will be able to access the loudspeaker.
- The 2-way radio's LPA channel and the LPA receiver must be programmed for the same QC code. All Ritron radios offer 50 different field-programmable QC codes from which to choose.

### **Paging the LPA-Series receiver with Digital Quiet Call (DCS) only:**

- To page the LPA receiver a user simply presses the 2-way radio's PTT and speaks while on the LPA channel.
- Your 2-way radio must be programmed for a channel dedicated to LPA receiver operation. Only those radios programmed with the LPA channel will be able to access the loudspeaker.
- The 2-way radio's LPA channel and the LPA receiver must be programmed for the same DQC code. All Ritron radios offer 104 different field-programmable DQC codes from which to choose.

### **Paging the LPA-Series receiver with 2-Tone Paging:**

- To page the LPA receiver the 2-way radio must first send the correct 2-Tone Paging code. Once access to the LPA receiver is accomplished, the user simply presses the 2-way radio's PTT and speaks while on the LPA channel. After a period of inactivity the LPA receiver is automatically reset, and will then require the correct 2-Tone Paging code to re-gain access.
- Only 2-way radios programmed to send the correct 2-Tone code on the LPA channel can access the LPA receiver. However, once access is gained, any 2-way radio that operates on the LPA channel can access the LPA receiver up until the time that the LPA receiver has automatically reset.
- Can be used in conjunction with QC or DQC for added security. The 2-way radio and the LPA receiver must be programmed for the same QC or DQC code.

### **Paging the LPA-Series receiver with Selcall:**

- To page the LPA receiver the 2-way radio must be programmed to send the correct Selcall code every time the PTT is pressed. The user simply presses the 2-way radio's PTT and speaks while on the LPA channel.
- Only 2-way radios programmed to send the correct Selcall code on the LPA channel can access the LPA receiver.
- Can be used in conjunction with QC or DQC for added security. The 2-way radio and the LPA receiver must be programmed for the same QC or DQC code.

## Ritron recommends the use of a dedicated channel frequency for LPA operation.

### When operating on unique frequencies dedicated to LPA operation:

- Your 2-way radios must be programmed for a channel dedicated to LPA operation.
- LPA-Series receiver operation is limited to radios programmed with the dedicated LPA channel.
- The use of 2-tone or Selcall paging to address the LPA receiver is not required, but can still be used if additional access security is desired.
- Without 2-tone or Selcall paging the LPA receiver can be addressed by simply selecting the LPA channel on your 2-way radio and pressing the PTT button to talk.
- You may need to license additional frequencies (not necessary with LPA-V150 programmed for MURS frequencies, see [Table 1](#) in the Programming section).

### When operating on your normal 2-way communication frequencies:

- Messages received by the LPA-Series receiver and broadcast on the wired PA system are also heard on your 2-way radios.
- LPA operation is not possible when the channel is being used for 2-way communications.
- The use of 2-tone or Selcall paging is required to address the LPA receiver, otherwise all 2-way communication is heard on the wired PA system.
- Any user on your 2-way channel can broadcast over the wired PA system once the LPA receiver is activated, even if their 2-way radio is not programmed with the correct 2-tone paging code.
- There is no need to license additional frequencies.

## 1.4 Compatibility with other RITRON model radios

The LPA-Series receiver is available in both VHF (LPA-V150, 150-165 MHz) and UHF (LPA-U450, 450-470 MHz) business band frequencies. LPA receivers can be accessed with radios programmed for Quiet Call (CTCSS), Digital Quiet Call (DCS), 2-Tone Paging, or Selcall paging formats. The following chart can be used to determine compatibility with existing Ritron radios.

### VHF models compatible with LPA-V150

### UHF models compatible with LPA-U450

Model	Type	QC	DQC	2-Tone	Selcall	Model	Type	QC	DQC	2-Tone	Selcall
JMX-141D	Portable	√				JMX-441D	Portable	√			
JMX-144D	Portable	√	√	√		JMX-444D	Portable	√	√	√	
JMX-146D	Portable	√				JMX-446D	Portable	√	√	√	
JBS-147D	Base	√	√	√	√	JBS-447D	Base	√	√	√	√
* JV-110	Portable	√	√	√		* JU-410	Portable	√	√	√	
RPM-160	Mobile	√	√	√	√	RPM-460	Mobile	√	√	√	√
RQX-111	Callbox	√	√	√	√	RQX-411	Callbox	√	√	√	√
RQX-117	Callbox	√	√	√	√	RQX-417	Callbox	√	√	√	√
RQX-127-XT	Callbox	√	√	√	√	RQX-427-XT	Callbox	√	√	√	√
PT-150	Portable	√	√	√	√	PT-450	Portable	√	√	√	√
PT-150M	Portable	√	√	√	√	PT-450-S	Portable	√	√	√	√

\* 2-Tone paging available with Rev 6.0 or greater Firmware Only. See label inside radio battery compartment for firmware revision.

# 2

## Installation

Proper installation of the LPA-Series receiver is critical to the performance and overall satisfaction with your system. With careful consideration and planning the LPA-Series can receive a radio signal from up to a mile away and broadcast it over your wired PA system. This section will help you plan an installation that is best suited for your environment.

### 2.1 Radio coverage site survey

Ritron recommends that you do a “radio coverage site survey” before permanently installing the LPA-Series receiver.

**This will require 2 people and 2 charged portable radios.**

Every building is different, and therefore, no “single” rule applies when it comes to where to install the LPA receiver and antenna for optimal coverage. Ideally, you would like to install the LPA-Series receiver in close proximity to the wired PA amplifier for easy installation. Begin your site survey by locating person #1 at the wired PA amplifier to see if a simple installation is possible. If that is not possible, an alternative site must be found where:

1. AC power is available for the LPA receiver.
2. A shielded, twisted pair cable can be routed from the LPA receiver to the PA amplifier.

In general, the antenna of the LPA receiver is the “pivot” point for all communication. We’re trying to optimize the location of the antenna in order to reduce the obstructions and distance the radio signal must travel in order to get from any point in the desired coverage area to the antenna connected to the LPA receiver. By attempting to install the ANTENNA for the LPA receiver “in the center” of the desired coverage area, we reduce the distance the radio signal must travel by ½. If you’re attempting to cover a high rise building (e.g. 15 floors), go to a location half way up (e.g. 7th floor), and in the center of the building.



#### **Radio range can be extended with the use of an external antenna.**

The antenna can be installed at a higher elevation than is possible with the attached antenna.

The [Ritron RAM-1545](#) VHF/UHF magnet-mount antenna has a 25 ft. cable to allow optimum antenna location.



#### **Preparing for the radio coverage site survey:**

1. Charge the radio batteries for at least 12 hours.
2. When charged, make sure both radios are set to the same channel.

**Note:** If you do not intend to route LPA communications through a repeater, the portable radios should be set to a channel programmed for direct radio-to-radio communication, NOT through the repeater.

**Conducting the radio coverage site survey:**

1. Person #1 will take one portable radio and go to the location you would “most likely” install the antenna for the LPA receiver (see FIG-2). This person will “simulate” the type of coverage you can expect, IF, the antenna for the LPA receiver was installed in this location. If necessary, position this person on a ladder to more accurately mimic the height you intend to mount the antenna.  
  
BE ADVISED – you may have to try several heights and/or locations before settling on the best location.
2. While person #1 remains stationary, person #2 will take the second radio and “walk the site”. While “walking the site” person #2 must attempt to maintain radio contact periodically with person #1. This survey process will reveal whether or not radio coverage is acceptable IF you install the antenna at the person #1 location. Generally speaking, coverage will be slightly better when the LPA receiver and antenna are permanently installed.
3. If coverage is inadequate, Person #1 will need to relocate to a new location and repeat the process until range and coverage are optimized.

**Hints:** Typically, the higher the antenna the better but, NOT always. Every site is different. Thick, reinforced concrete, steel walls and vertical fire panels in ceilings can work to block the penetration of radio signals creating dead spots. You may want to gradually lower the height of the antenna and/or its location and repeat your site survey to see if coverage improves. It is best to change one variable at a time e.g. antenna height, location and then repeat the process.

4. For sites where coverage is desired in multiple buildings, such as an office complex, an external mounted antenna may be required. Before considering an external installation of the antenna, a site survey should be attempted with person #1 positioned inside a centrally located building at the highest possible elevation (see FIG-3). Person #2 will “walk the site”, communicating with person #1 from inside all buildings and at all outside areas where radio coverage is desired.

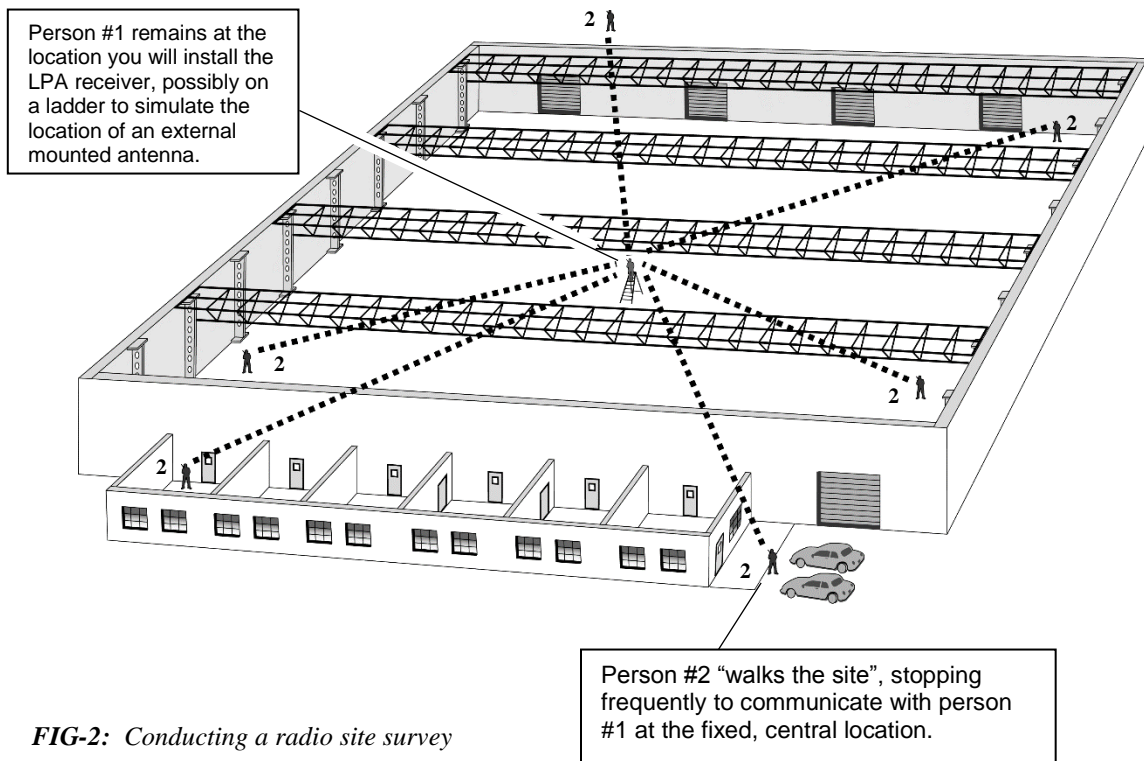



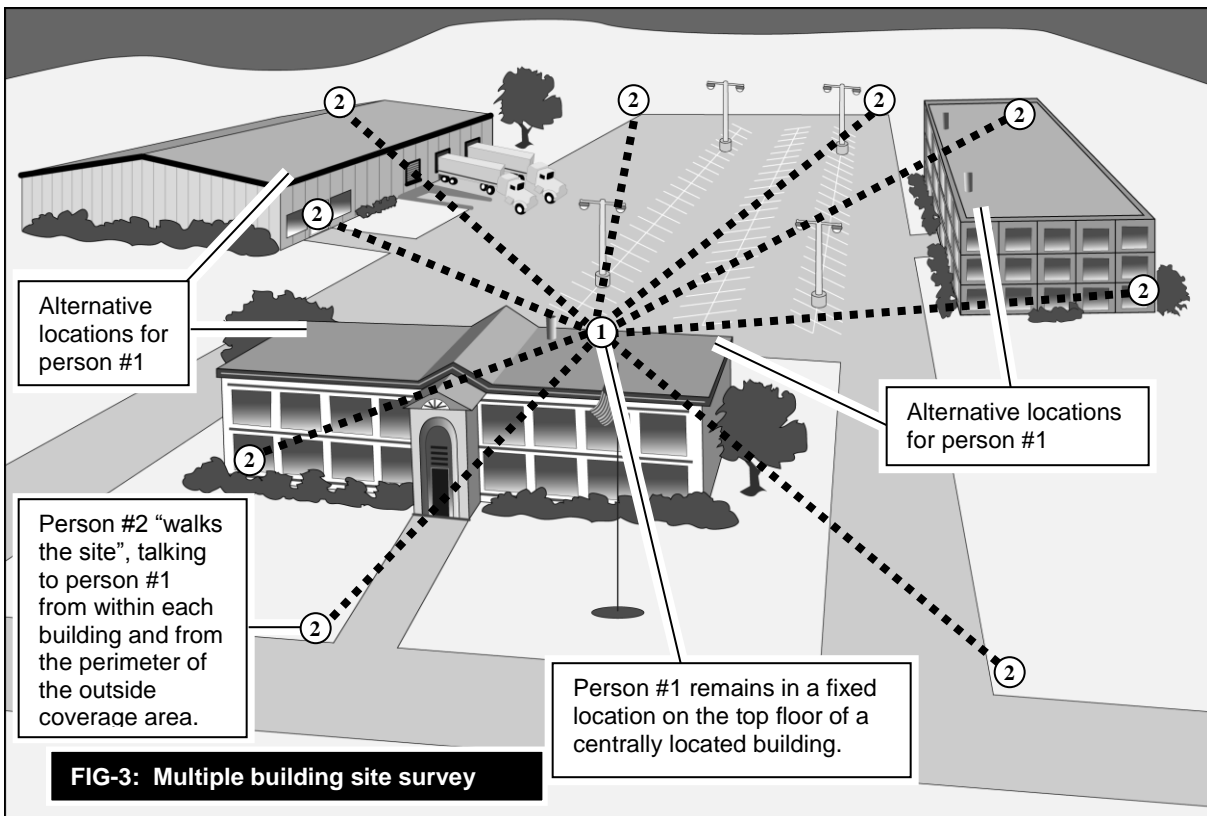
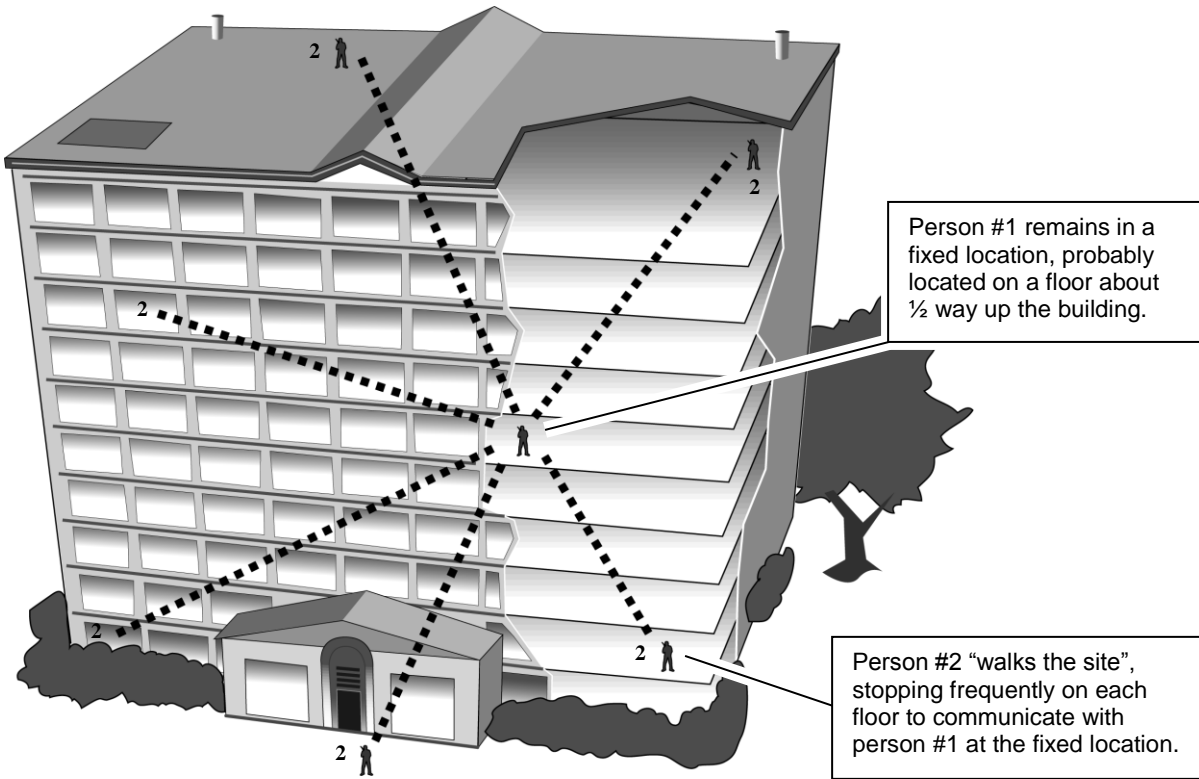

## Installing a Magnetic Mount Antenna for the LPA-Series Receiver

A magnetic mount antenna should be installed in a location, which is at, or as close as possible to the best location as determined by the site survey. The antenna's magnetic base must be attached to a piece of metal (i.e. steel or iron). The antenna comes with 12 feet of attached co-axial cable\* so you can remotely locate the antenna up to 12 feet away from the LPA-Series receiver. The antenna cable MUST run directly away from the LPA receiver.

\* Do NOT attempt to cut, shorten or splice this cable in any way.

For best performance the magnetic mount antenna must be:

- Mounted on a metal surface e.g. steel or iron. This metal mounting surface MUST be at least 2 feet square with the antenna positioned in the center. The antenna's internal magnet will secure it to the surface. Do NOT place adhesives between the bottom of the antenna mounting surface and the metal mounting surface itself.
- Orient the antenna so that the element itself is vertical. The antenna can be mounted upside down with no affect on performance. Just make sure the antenna element is vertical.
- Mounted away from other metal objects, walls, and structures. Avoid surrounding the antenna or "shielding" it by locating it too closely to metal walls, inside an elevator shaft, in recessed girders, firewalls or ceilings.

## 2.2 LPA-Series radio receiver installation

**Installation of the LPA receiver is critical to the effective radio coverage of the radio PA system. Without proper installation the maximum possible distance between the calling radio and the LPA receiver will be significantly reduced.**

### Guidelines for installing the LPA-Series receiver:

- The radio receiver box must be located inside, out of the elements.
- For best radio coverage the LPA receiver should be installed in a central location and as high up as possible.
- For maximum radio coverage the antenna should be in a vertical orientation and should not be touching or surrounded by large metal objects. The receiver box can be mounted horizontally as long as the antenna is in a vertical position.
- Do not install the LPA receiver in a high traffic location with the possibility that the receiver box would be struck, become unplugged, or disconnected from the PA amplifier.
- If connection to the PA amplifier is via it's AUX IN, the LPA receiver must be within 6 ft. of the PA amplifier.
- Do not wind, loop or otherwise allow the power cord from the RPS-1B power cube to contact the antenna. The power cord should be routed away from the antenna.
- Be sure there is a convenient source of 110VAC power for the RPS-1B power cube.

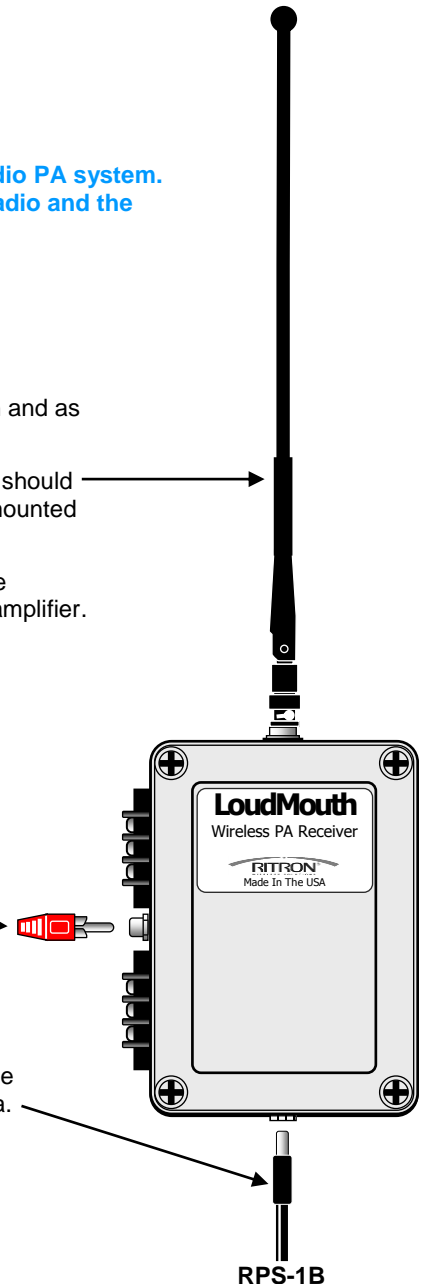

## 2.3 LPA-Series AUX IN installation

The LPA-Series receiver can connect to the AUX INPUT of a public address amplifier if the LPA receiver is installed in close proximity to the PA amplifier.

- The RCA phono cable required for interconnection should be no longer than 6 feet. Installations requiring LPA receiver location greater than 6 feet from the PA amplifier must use the 600Ω balanced output.
- When using the PA amplifier AUX INPUT it is important to remember that received messages from the LPA receiver will be treated exactly the same way any other audio device connected to the AUX INPUT. On many PA amplifiers the AUX INPUT audio is automatically muted whenever audio is present on the MIC INPUT. Check the owner's manual for the PA amplifier to determine AUX INPUT operation and the effect it will have on LPA operation.

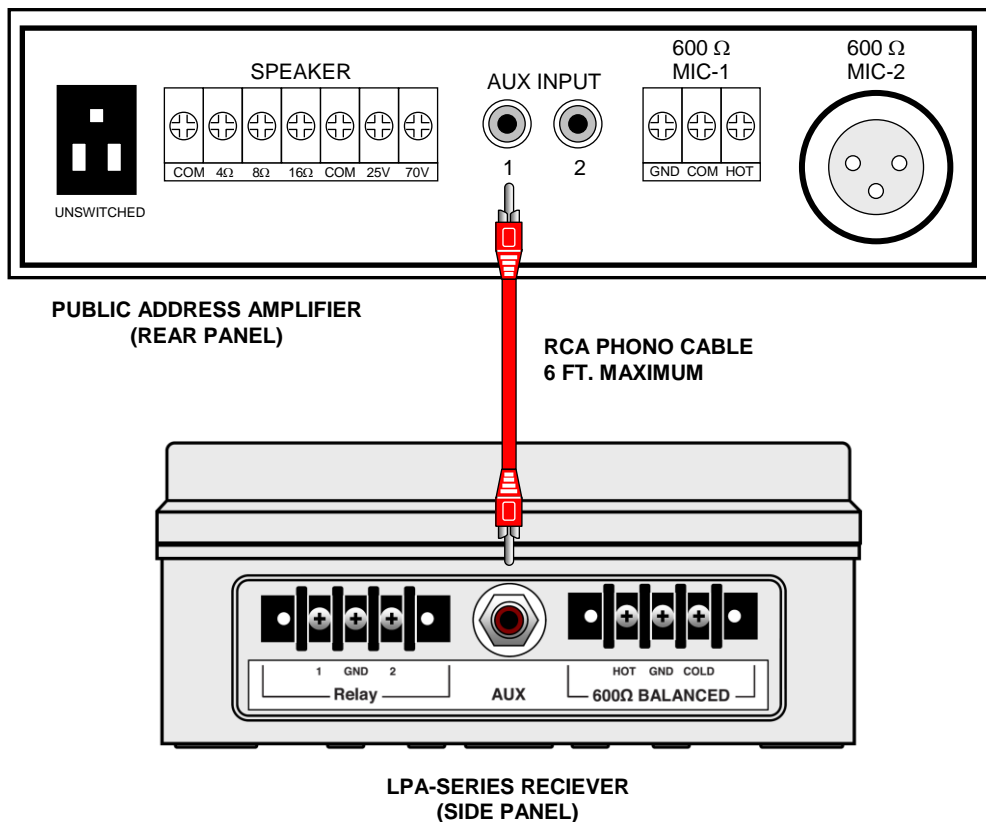

## 2.4 LPA-Series 600Ω BALANCED installation

The LPA-Series receiver can be connected to the 600Ω balanced MIC INPUT of a public address amplifier when the LPA receiver is not located close to the PA amplifier.

- When an LPA radio message is received, the LPA receiver will send the audio to the 600 Ω microphone input of the PA amplifier.
- A typical balanced cable contains two identical wires, which are twisted together and then wrapped with a third conductor (foil or braid) that acts as a shield. The wires are twisted together, to reduce interference from electromagnetic induction. Twisting makes the loop area between the conductors as small as possible, and ensures that a magnetic field that passes equally through adjacent loops will induce equal but opposite currents, which cancel out. The separate shield of a balanced audio connection also yields a noise rejection advantage over an unbalanced two-conductor arrangement (such as AUX IN) where the shield must also act as the signal return wire. Any noise currents induced into a balanced audio shield will not therefore be directly modulated onto the signal, whereas in a two-conductor system they will be. This also prevents ground loop problems, by separating the shield/chassis from signal ground.

**NOTE:** To minimize noise it is often necessary to connect the ground shield at only one end of the cable.

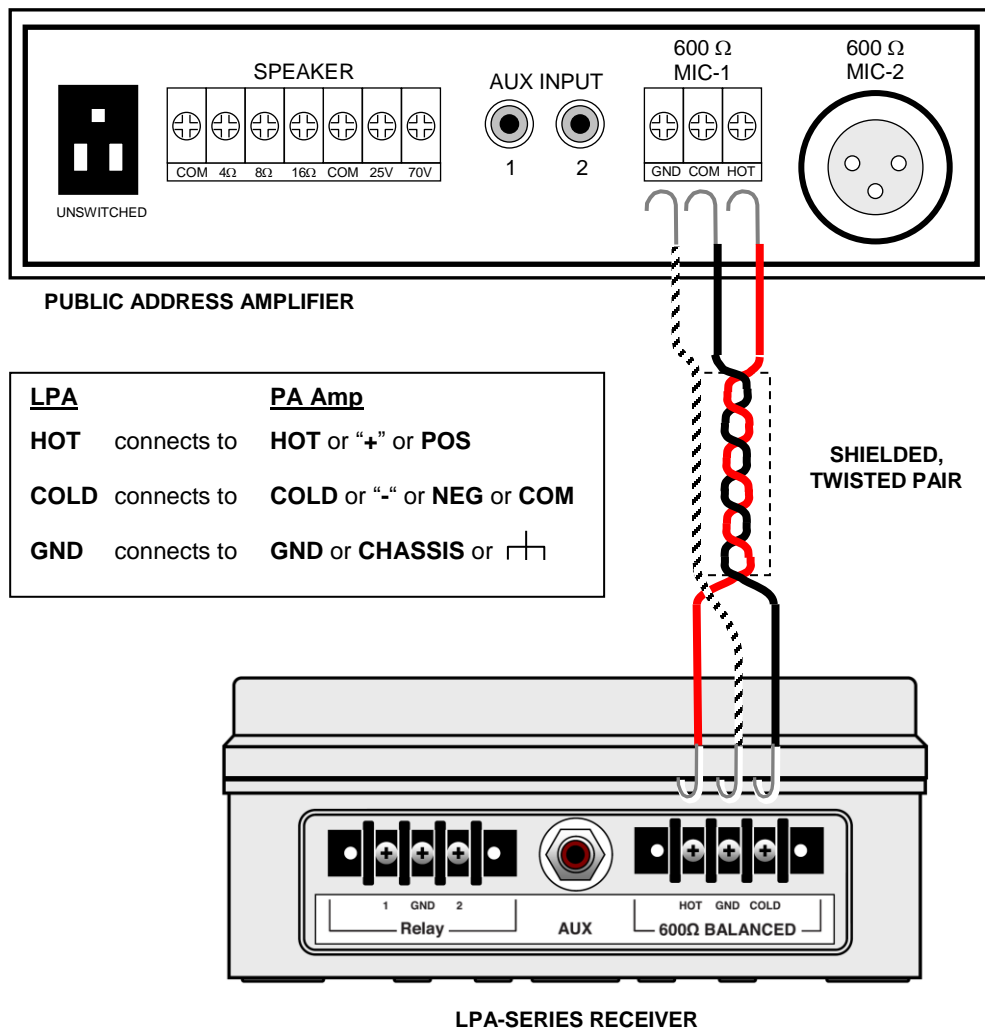

## 2.5 LPA-Series RELAY installation

The LPA-Series receiver can be set to provide a relay switch closure any time a valid message is received.

- RELAY switch connections 1 and 2 are normally open. When an LPA radio message is received, the RELAY switch is closed with connections 1 and 2 shorted.
- RELAY switch connections 1 and 2 can be used to provide a “Priority”, “Override” or “Emergency” signal to the PA amplifier.
- The LPA-Series receiver can be modified so RELAY switch connections 1 and 2 are normally closed, and will open when an LPA radio message is received. Contact Ritron for details.

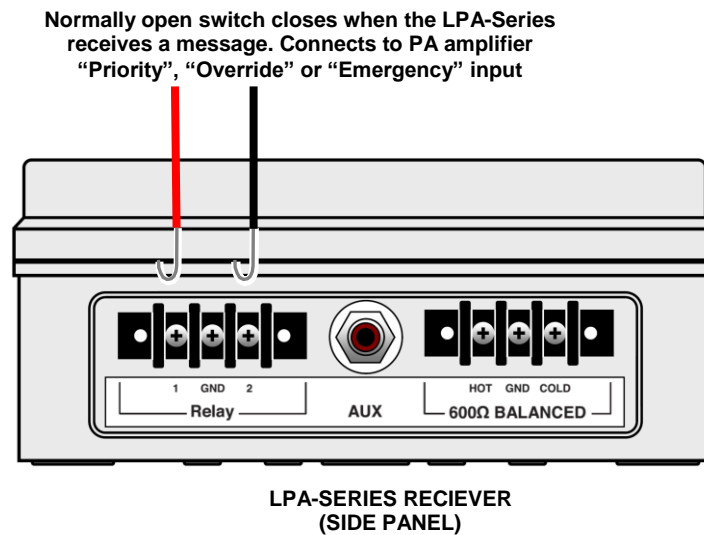

Switch closure to ground when the LPA-Series receives a message.

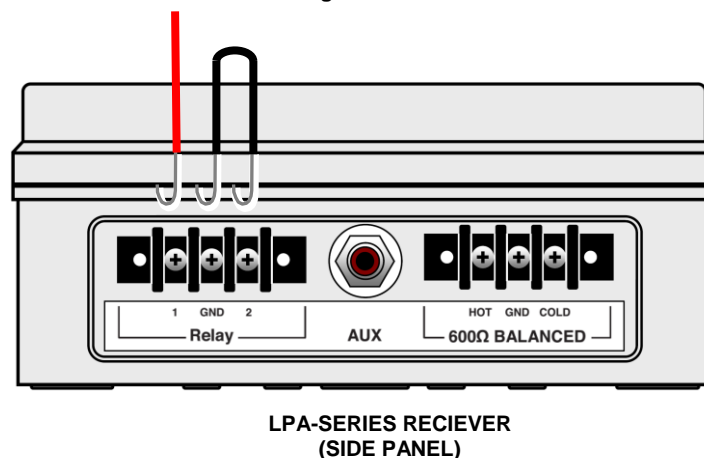

# 3

## Programming

For most installations the LPA-Series receiver can be programmed in the field without the need for Ritron PC Programmer 12.0.8. Field programming is accomplished in 3 easy steps. First, the radio frequency and tone codes are entered. Second, the selective signaling code is entered (if used). Third, the LPA-Series options and volume setting are entered.

### 3.1 LPA-Series Field Programming Overview

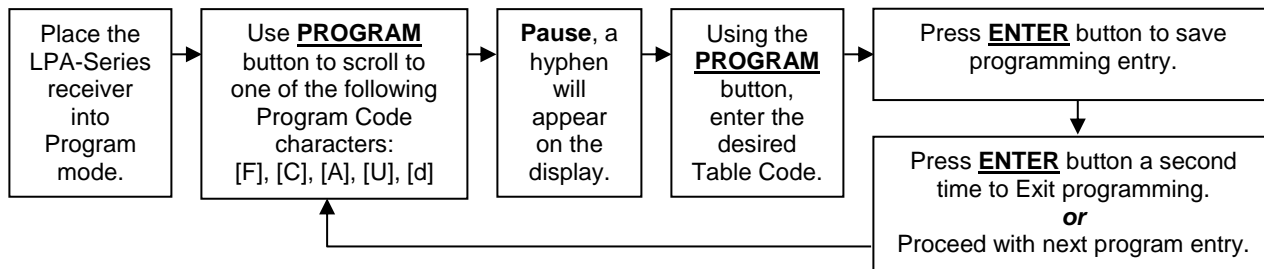

#### Program Codes

#### Table Codes



Enter a 2-digit Frequency code from Table 1 **and** a 2-digit QC code from Table 2 **or** Enter a 2-digit Frequency code from Table 1 **and** a 3-digit DQC code from Table 3.



Enter a 2-digit, 2-Tone Paging code from Table 4 **or** Enter any 3 – 7-digit Selcall Paging Code.



Enter a 2-digit Feature code from Table 5 to:

- Enable or disable a Pre-Announce Tone.
- Enable or disable Record and Play operation.
- Set a Record and Play delay time.
- Set to repeat a Record and Play message.
- Enable or disable Weather Alert feature (VHF models only)
- Set the LPA-Series receiver for wideband operation.
- Enable or Disable Relay operation.
- Reset LPA-Series receiver to Factory default programming.



Enter the desired Audio Volume Level as a 2-digit number from 05-99.



Enter the 1-digit NOAA Weather Frequency code from Table 6 (**VHF models only**) This only programs the NOAA weather frequency, the Weather Alert feature must be enabled using the Special Features code in Table 5.

## 3.2 Readout Current Frequency, Tone and Selective Signaling Codes

1. Loosen the (4) captive screws in the front corners of the case. These screws are captive to the housing; to prevent damaging them, **DO NOT** remove the screws from the housing.
2. Separate the case front from the case back, leaving the RPS-1B power supply connected to the radio.
3. Press and release the **PROGRAM** button (See [LPA-Series receiver assembly](#) on page 2 for location). The radio will immediately begin to display a series of digits; with each digit separated by a hyphen.
4. Write down the all the digits. The first two digits indicate the frequency code and the next two digits the tone code; see [Table 1](#) and [Table 2](#) on page 14. In this example an LPA-U450 is programmed to operate on the “Brown Dot” frequency of 464.500 MHz (Frequency code “04”) with 100.0 Hz tone (Tone code “12”).

FREQUENCY CODE

TONE CODE

5. If a 5<sup>th</sup> digit is displayed, the LPA receiver has been programmed for DQC and the last three digits indicate the DQC code; see [Table 3](#) on page 14. In this example an LPA-U450 was programmed to operate on the “Brown Dot” frequency of 464.500 MHz (Frequency code “04”) with a DQC code of “723”.

FREQUENCY CODE

DQC CODE

6. If more than 5 digits are displayed, the radio has been programmed for Selective Signaling Decode. The frequency and tone codes will be displayed, followed by a “C”, then the radio will display either the 2-digit, 2-Tone paging code (see [Table 4](#) on 15) or the 3-7 digit Selcall code. In this example an LPA-U450 was programmed to operate on the “Brown Dot” frequency of 464.500 MHz (Frequency code “04”) with 100.0 Hz tone (Tone code “12”) and 2-tone paging decode frequencies of 330.5 Hz and 569.1 Hz (2-Tone code “91”).

FREQUENCY CODE

TONE CODE

PAGING CODE

7. If the LPA-Series receiver is PC programmed with any frequency not listed in [Table 1](#) on page 14, the radio will display a code “99” for the frequency code. The PC programmer will be required to readout the radios frequency programming.
8. Normal radio operation resumes after the programming information has been displayed.

### 2013 FCC Narrowband Mandate

On January 1, 2013, pursuant to the FCC Narrowband mandate, you will no longer be allowed to operate wideband transmitters (25 kHz) in the frequency bands from 150 MHz to 512 MHz.

Ritron will begin manufacturing narrowband compatible LPA receivers starting in December 2012. At that time, customer orders will begin to be filled with radios manufactured for FCC narrowband compatibility. Specifically, table frequencies will be converted to narrowband. Since Part 15 receivers are not subject to the narrowband mandate, you will still be able to set the LPA receiver for wideband operation via field programming (See Section 3.5 – Program LPA-Series Features), or by using the PC Programmer. These radios will be clearly marked as “FCC Narrowband Compatible”.















For a complete list of all Ritron radios capable of narrowband operation; a Ritron FAQ on the subject, and various links on the FCC website dealing with Narrowbanding go to:

[www.ritron.com/narrowband](http://www.ritron.com/narrowband)

If you have any questions contact us at 1-800-872-1872

### 3.3 Program Frequency & Tone Codes

To match other radios, the owner can select Frequency, Tone and DQC Codes from [Table 1](#), [Table 2](#) and [Table 3](#). In our example, we will program an LPA-U450 to operate on the "Brown Dot" frequency of 464.500 MHz with 100.0 Hz tone.

- |   |  |
|---|--|
| 04  | 1. Refer to <a href="#">Table 1</a> to determine the two-digit frequency code and write it down.   |
| 12  | 2. Refer to <a href="#">Table 2</a> to determine the two-digit tone code for 100.0 Hz and write it down.   |
|   | 3. Loosen the (4) captive screws in the front corners of the case. These screws are captive to the housing; to prevent damaging them, <b>DO NOT</b> remove the screws from the housing.  |
|   | 4. Separate the case front from the case back, leaving the RPS-1B power supply connected to the radio.   |
|    | 5. Press and <b>HOLD</b> the <b>PROGRAM</b> button. A "P" will appear on the program display as you enter program mode and the radio will beep rapidly.  |
|    | 6. Release the <b>PROGRAM</b> button after the beeping has stopped. The radio will emit a triple beep indicating that the radio is in program mode and a hyphen will appear on the program display.  |
|    | 7. Scroll to the character "F" by clicking the <b>PROGRAM</b> button until the program display shows the correct character. <b>Pause</b> —the radio will sound a low tone and show a hyphen across the center of the display to indicate that it is ready to accept the first digit of the frequency code.   |
| <div style="display: flex; align-items: center;"> <div style="writing-mode: vertical-rl; transform: rotate(180deg); font-size: 8px; margin-right: 5px;">FREQUENCY CODE</div> <div style="margin-right: 10px;"> <br/>  </div> </div>     | 8. Enter the 1 <sup>st</sup> digit of the frequency code by clicking the <b>PROGRAM</b> button until the program display shows the desired number. <b>Pause</b> —the radio will sound a low tone and show a hyphen across the center of the display to indicate that it is ready to accept the next digit.   |
| <div style="display: flex; align-items: center;"> <div style="writing-mode: vertical-rl; transform: rotate(180deg); font-size: 8px; margin-right: 5px;">FREQUENCY CODE</div> <div style="margin-right: 10px;"> <br/>  </div> </div> | 9. Enter the 2 <sup>nd</sup> digit of the frequency code by clicking the <b>PROGRAM</b> button until the program display shows the desired number. <b>Pause</b> —the radio sounds a low tone and will show a hyphen across the center of the display to indicate that it is ready to accept the next digit.  |
| <div style="display: flex; align-items: center;"> <div style="writing-mode: vertical-rl; transform: rotate(180deg); font-size: 8px; margin-right: 5px;">TONE CODE</div> <div style="margin-right: 10px;"> <br/>  </div> </div>      | 10. Enter the 1 <sup>st</sup> digit of the tone code (or 1 <sup>st</sup> digit of the DQC code) by clicking the <b>PROGRAM</b> button until the program display shows the desired number. <b>Pause</b> —the radio sounds a low tone and will show a hyphen across the center of the display to indicate that it is ready to accept the next digit. |
| <div style="display: flex; align-items: center;"> <div style="writing-mode: vertical-rl; transform: rotate(180deg); font-size: 8px; margin-right: 5px;">TONE CODE</div> <div style="margin-right: 10px;"> <br/>  </div> </div>      | 11. Enter the 2 <sup>nd</sup> digit of the tone code (or 2 <sup>nd</sup> digit of the DQC code) by clicking the <b>PROGRAM</b> button until the program display shows the desired number. <b>Pause</b> —the radio sounds a low tone and will show a hyphen across the center of the display to indicate that it is ready to accept the next digit. |
| <div style="display: flex; align-items: center;"> <div style="writing-mode: vertical-rl; transform: rotate(180deg); font-size: 8px; margin-right: 5px;">TONE CODE</div> <div style="margin-right: 10px;"> <br/>  </div> </div>      | 12. <b>FOR DQC CODES ONLY</b> – Enter the 3 <sup>rd</sup> digit of the DQC code by clicking the <b>PROGRAM</b> button until the program display shows the desired number. <b>Pause</b> —the radio sounds a low tone and will show a hyphen across the center of the display to indicate that it is ready to accept the next digit.                 |
|    | 13. Press and release the <b>ENTER</b> button to save your programming. A triple beep will sound to indicate that programming was successful and a hyphen will appear on the program display. The radio is now ready for another program entry.  |
|    | <b>NOTE:</b> An error tone will sound if you attempt to save an incorrect code, an "E" will appear on the display. Check the digits you are attempting to enter, then re-enter.  |
|   | 14. Once you have made your final program entry, press the <b>ENTER</b> button a final time to exit programming mode. The Program display will be blank and the radio will be ready for use. The LPA-Series receiver will exit program mode automatically after 30 seconds if no program entries are attempted.                                    |



**Table 1: Programmable Frequency Codes**

VHF Business Band				UHF Business Band				UHF Business Band				UHF Business Band			
Code	Frequency	ColorDot	BW	Code	Frequency	ColorDot	BW	Code	Frequency	ColorDot	BW	Code	Frequency	ColorDot	BW
03	151.625	Red Dot	12.5 †	01	467.7625	J	125 †	32	461.0875		12.5	63	466.2375		12.5
04	151.955	Purple Dot	12.5 †	02	467.8125	K	125 †	33	461.1125		12.5	64	466.2625		12.5
05	151.925		12.5 †	03	464.5500	Yellow Dot	125 †	34	461.1375		12.5	65	466.2875		12.5
06	154.540		12.5 †	04	464.5000	Brown Dot	125 †	35	461.1625		12.5	66	466.3125		12.5
07	154.515		12.5 †	05	467.8500	Silver Star	125 †	36	461.1875		12.5	67	466.3375		12.5
08	154.655		12.5 †	06	467.8750	Gold Star	125 †	37	461.2125		12.5	68	466.3625		12.5
10	151.715		12.5 †	07	467.9000	Red Star	125 †	38	461.2375		12.5	69	467.7875		12.5
09	151.685		12.5 †	08	467.9250	Blue Star	125 †	39	461.2625		12.5	70	467.8375		12.5
11	151.775		12.5 †	09	469.2625		125 †	40	461.2875		12.5	71	467.8625		12.5
12	151.805		12.5 †	10	462.5750	White Dot	125 †	41	461.3125		12.5	72	467.8875		12.5
13	151.835		12.5 †	11	462.6250	Black Dot	125 †	42	461.3375		12.5	73	467.9125		12.5
14	151.895		12.5 †	12	462.6750	Orange Dot	125 †	43	461.3625		12.5	74	469.4875		12.5
15	154.490		12.5 †	13	464.3250		125 †	44	462.7625		12.5	75	469.5125		12.5
16	151.655		12.5 †	14	464.8250		125 †	45	462.7875		12.5	76	469.5375		12.5
17	151.745		12.5 †	15	469.5000		125 †	46	462.8125		12.5	77	469.5625		12.5
18	151.865		12.5 †	16	469.5500		125 †	47	462.8375		12.5	99	Custom programmed	---	
24	151.700		12.5	17	463.2625		125 †	48	462.8625		12.5	<b>Canadian Models</b>			
25	151.760		12.5	18	464.9125		125 †	49	462.8875		12.5	<b>UHF Canada</b>			
26	152.700		12.5 †	19	464.6000		125 †	50	462.9125		12.5	01	458.6625		25
99	Custom programmed		---	20	464.7000		125 †	51	464.4875		12.5	02	469.2625		25
<b>VHF MURS **</b>				21	462.7250		125 †	52	464.5125		12.5	<b>VHF Canada</b>			
01	154.600	Green Dot	25	22	464.5000		12.5	53	464.5375		12.5	01	151.055		25
02	154.570	Blue Dot	25	23	464.5500		12.5	54	464.5625		12.5	02	151.115		25
19	151.820	MURS	12.5	24	467.7625		12.5	55	466.0375		12.5	<b>British Columbia</b>			
20	151.880	MURS	12.5	25	467.8125		12.5	56	466.0625		12.5	01	154.100		25
21	151.940	MURS	12.5	26	467.8500		12.5	57	466.0875		12.5	02	158.940		25
22	154.600	MURS	12.5	27	467.8750		12.5	58	466.1125		12.5				
23	154.570	MURS	12.5	28	467.9000		12.5	59	466.1375		12.5				
				29	467.9250		12.5	60	466.1625		12.5				
				30	461.0375		12.5	61	466.1875		12.5				
				31	461.0625		12.5	62	466.2125		12.5				

**Notes:** \*\* MURS frequencies do not require an FCC license. All other frequencies require an FCC license.  
 † Frequency code was 25 KHz bandwidth prior to the 2013 FCC Narrowband Mandate.  
 • BW is the bandwidth in kHz. 12.5 kHz = narrow band channel, 25 kHz = wide band channel.

**Table 2: Interference Eliminator Programmable QC Tone Codes**

Code	Frequency	Code	Frequency	Code	Frequency	Code	Frequency	Code	Frequency	Code	Frequency
01	67.0	10	94.8	19	127.3	28	173.8	37	241.8	46	189.9
02	71.9	11	97.4	20	131.8	29	179.9	38	250.3	47	196.6
03	74.4	12	100.0	21	136.5	30	186.2	39	69.4	48	199.5
04	77.0	13	103.5	22	141.3	31	192.8	40	159.8	49	206.5
05	79.7	14	107.2	23	146.2	32	203.5	41	165.5	50	229.1
06	82.5	15	110.9	24	151.4	33	210.7	42	171.3	51	254.1
07	85.4	16	114.8	25	156.7	34	218.1	43	177.3	00	No Tone
08	88.5	17	118.8	26	162.2	35	225.7	44	No Tone		
09	91.5	18	123.0	27	167.9	36	233.6	45	183.5		

**Table 3: Digital Interference Eliminator Programmable DQC Tone Codes**

Code	Code	Code	Code	Code	Code	Code	Code	Code	Code
023	065	132	205	255	331	413	465	612	731
025	071	134	212	261	332	423	466	624	732
026	072	143	223	263	343	431	503	627	734
031	073	145	225	265	346	432	506	631	743
032	074	152	226	266	351	445	516	632	754
036	114	155	243	271	356	446	523	645	
043	115	156	244	274	364	452	532	654	
047	116	162	245	306	365	454	546	664	
051	122	165	246	311	371	455	565	703	
053	125	172	251	315	411	462	606	712	
054	131	174	252	325	412	464	662	723	

## 3.4 Program Paging Codes

For paging, it is desirable to program the LPA-Series receiver for 2-Tone or Selcall operation. The user is able to field program the radio for one of the 9 pre-determined 2-tone pairs specified in [Table 4](#), or for a 3-7 digit Selcall code. 2-Tone codes correspond to field programmable 2-Tone encode (transmit) codes available in other RITRON portable and base radios. In our example we will program an LM-U450 to operate with 2-Tone Paging Code 94 frequencies of 389.0 and 669.9 Hz.

- |                |   |  |
|----------------|---|--|
| <b>94</b>      | <ol style="list-style-type: none"> <li>1. Refer to <a href="#">Table 4</a> to determine the two-digit code for 2-tone decode on 389.0 and 669.9 Hz and write it down.</li> <li>2. Loosen the (4) captive screws in the front corners of the case. These screws are captive to the housing; to prevent damaging them, <b>DO NOT</b> remove the screws from the housing.</li> <li>3. Separate the case front from the case back, leaving the RPS-1B power supply connected to the radio.</li> </ol> |  |
|                | <ol style="list-style-type: none"> <li>4. Press and <b>HOLD</b> the <b>PROGRAM</b> button. A "P" will appear on the program display as you enter program mode and the radio will beep rapidly.</li> </ol>   |  |
|                | <ol style="list-style-type: none"> <li>5. Release the <b>PROGRAM</b> button after the beeping has stopped. The radio will emit a triple beep indicating that the radio is in program mode and a hyphen will appear on the program display.</li> </ol>   |  |
|                | <ol style="list-style-type: none"> <li>6. Scroll to the character "C" by clicking the <b>PROGRAM</b> button until the program display shows the correct character. <b>Pause</b>—the radio will sound a low tone and show a hyphen across the center of the display to indicate that it is ready to accept the first digit of the 2-Tone or Selcall code.</li> </ol>   |  |
| 2-TONE<br>CODE |   | <ol style="list-style-type: none"> <li>7. Enter the 1<sup>st</sup> digit of the 2-Tone or Selcall code by clicking the <b>PROGRAM</b> button until the program display shows the desired number. <b>Pause</b>—the radio will sound a low tone and show a hyphen across the center of the display to indicate that it is ready to accept the next digit.</li> </ol> |
|                |   | <ol style="list-style-type: none"> <li>8. Enter the 2<sup>nd</sup> digit of the 2-Tone or Selcall code by clicking the <b>PROGRAM</b> button until the program display shows the desired number. <b>Pause</b>—the radio sounds a low tone and show a hyphen across the center of the display to indicate that it is ready to accept the next digit.</li> </ol>     |
|                | <ol style="list-style-type: none"> <li>9. <b>FOR SELCALL CODES ONLY</b> – Enter the 3<sup>rd</sup>, 4<sup>th</sup>, 5<sup>th</sup>, 6<sup>th</sup>, and 7<sup>th</sup> digits of the Selcall code by clicking the <b>PROGRAM</b> button until the program display shows the desired number. <b>Pause</b>—the radio sounds a low tone and will show a hyphen across the center of the display to indicate that it is ready to accept the next digit.</li> </ol>                                    |  |
|                | <ol style="list-style-type: none"> <li>10. Press and release the <b>ENTER</b> button to save your programming. A triple beep will sound to indicate that programming was successful and a hyphen will appear on the program display. The radio is now ready for another program entry.</li> </ol>   |  |
|                | <p><b>NOTE:</b> An error tone will sound if you attempt to save an incorrect code, an "E" will appear on the display. Check the digits you are attempting to enter, then re-enter.</p>  |  |
|                | <ol style="list-style-type: none"> <li>11. Once you have made your final program entry, press the <b>ENTER</b> button a final time to exit programming mode. The Program display will be blank and the radio will be ready for use. The LPA-Series receiver will exit program mode automatically after 30 seconds if no program entries are attempted.</li> </ol>   |  |

**Table 4: 2-Tone Paging Codes**







Code	Tone 1	Tone 2
90	*	*
91	330.5	569.1
92	349.0	600.9
93	368.5	634.5
94	389.0	669.9
95	410.8	707.3
96	433.7	746.8
97	457.9	788.5
98	483.5	832.5
99	330.5	600.9
00	No Selective Signaling	

### IMPORTANT NOTE:

- \* If the LPA-Series receiver displays 2-Tone Paging Code "90" on readout, it has been PC programmed for custom 2-Tone frequencies. Entering code "90" will cause the LPA-Series receiver to operate on the PC programmed custom 2-Tone frequencies.

## 3.5 Program LPA-Series Features

The LPA-Series receiver can be field programmed for a variety of features. Refer to [Table 5](#) for the two digit codes available for field programming. In our example we will program an LPA-U450 for Record and Play operation. The LPA-Series receiver is set from the factory with these  options **enabled**.

- |  |   |   |
|--|---|---|
| 25   | 1. Refer to <a href="#">Table 5</a> to determine the two-digit feature code and write it down.  |   |
|   | 2. Press and <b>HOLD</b> the <b>PROGRAM</b> button (See <a href="#">LPA-Series receiver assembly</a> on page 2 for location). A "P" will appear on the program display as you enter program mode and the radio will beep rapidly.   |   |
|   | 3. Release the <b>PROGRAM</b> button after the beeping has stopped. The radio will emit a triple beep indicating that the radio is in program mode and a hyphen will appear on the program display.   |   |
|   | 4. Scroll to the character "A" by clicking the <b>PROGRAM</b> button until the program display shows the correct character. <b>Pause</b> —the radio will sound a low tone and show a hyphen across the center of the display to indicate that it is ready to accept the first digit of the Feature code.  |   |
| FEATURES<br>CODE   |    | 5. Enter the 1 <sup>st</sup> digit of the feature code by clicking the <b>PROGRAM</b> button until the program display shows the desired number. <b>Pause</b> —the radio will sound a low tone and show a hyphen across the center of the display to indicate that it is ready to accept the next digit.  |
|  |    | 6. Enter the 2 <sup>nd</sup> digit of the feature code by clicking the <b>PROGRAM</b> button until the program display shows the desired number. <b>Pause</b> —the radio sounds a low tone and will show a hyphen across the center of the display to indicate that it is ready to accept the next digit. |
| <br> | 7. Press and release the <b>ENTER</b> button to save your programming. A triple beep will sound to indicate that programming was successful and a hyphen will appear on the program display. The radio is now ready for another program entry.<br><br><b>NOTE:</b> An error tone will sound if you attempt to save an incorrect code, an "E" will appear on the display. Check the digits you are attempting to enter, then re-enter. |   |
|  | 8. Once you have made your final program entry, press the <b>ENTER</b> button a final time to exit programming mode. The Program display will be blank and the radio will be ready for use. The LPA-Series receiver will exit program mode automatically after 30 seconds if no program entries are attempted.  |   |







**Table 5: LPA Feature Codes**

Code	Feature	Default	Description
<b>Special Features</b>			
21	Reset to Factory Defaults		Resets Wireless Speaker to Factory default programming.
22	Display Radio Revision		LPA receiver will display a sequence of 6 digits to identify operating code revision. This is helpful when troubleshooting the radio.
23	Pre-Announce Tone – On	√	Enable this feature to play a short tone over the PA system speakers whenever the LPA receiver receives a signal.
24	Pre-Announce Tone – Off		Disable Pre-Announce Tone.
25	Record and Play – On		When set received messages are recorded and played back over the PA system speakers immediately after the received signal is removed.
26	Record and Play – Off	√	Disable Record and Play feature.
29	Weather Alert – On		Enable this feature to receive local NOAA weather radio emergency broadcasts from the National Weather Service and play them over the PA system speaker. This feature is only available on the LPA-V150.
20	Weather Alert – Off	√	Disable Weather Alert.
<b>Wideband Operation (firmware revision 23.05 or higher, <u>or</u> serial number A100119000 or higher)</b>			
31	Wideband Operation Enable		When set the LPA receiver is forced into wideband operation, regardless of programming.
30	Wideband Operation Disable	√	LPA receiver reverts to the programmed bandwidth. See Table 1 for the normal table frequency bandwidth.
<b>Relay Operation (firmware revision 23.05 or higher, <u>or</u> serial number A100119000 or higher)</b>			
51	Relay – On		For radios equipped with a relay, set this option for relay closure when the LPA receives a valid signal. The relay will remain closed as long as a signal is received. If Record and Play is enabled, the relay will close as soon as a signal is received and remain closed throughout any Record and Play Delay and Recorded Message Replay.
50	Relay – Off	√	Set to disable any relay operation.
<b>Record and Play Operation (firmware revision 23.05 or higher)</b>			
60	Recorded Message Replay – 0 times	√	Recorded messages are repeated concurrently for the number of times programmed. (Record and Play must be enabled with code 25)
61	Recorded Message Replay – 1 time		
62	Recorded Message Replay – 2 times		
63	Recorded Message Replay – 3 times		
64	Recorded Message Replay – 4 times		
65	Record and Play Delay – 0 Sec.	√	Playback of a recorded received message is delayed for the programmed time whenever a valid incoming message is received. If the recorded message is longer than the programmed delay time the message plays back at the conclusion of recording. (Record and Play must be enabled with Code 25)
66	Record and Play Delay – 5 Sec.		
67	Record and Play Delay – 10 Sec.		
68	Record and Play Delay – 15 Sec.		
69	Record and Play Delay – 20 Sec.		

## 3.6 Program LPA-Series Volume

The LPA-Series receiver can be field programmed for any volume level between 05-99% by entering the volume level as a 2-digit code. The LPA receiver is set from the factory with a 50% volume setting. If your PA amplifier has independent volume control you should not have to adjust the LPA receiver volume. If there is no volume control, or if the PA amplifier volume control is pre-set for background music, you can adjust the input level to the PA amplifier by adjusting the LPA receiver volume. Field programming Volume Level sets both the voice and the pre-announce tone volume levels. The PC programmer is required for independent programming of the voice and the pre-announce tone volume.

In our example we will program an LPA-U450 for 25% Speaker Volume Level.

- |  |  |   |
|--|--|---|
|   | 1. Press and <b>HOLD</b> the <b>PROGRAM</b> button (See <a href="#">LPA-Series receiver assembly</a> on page 2 for location). A "P" will appear on the program display as you enter program mode and the radio will beep rapidly.  |   |
|   | 2. Release the <b>PROGRAM</b> button after the beeping has stopped. The radio will emit a triple beep indicating that the radio is in program mode and a hyphen will appear on the program display.  |   |
|   | 3. Scroll to the character "U" by clicking the <b>PROGRAM</b> button until the program display shows the correct character. <b>Pause</b> —the radio will sound a low tone and show a hyphen across the center of the display to indicate that it is ready to accept the first digit of the volume setting.     |   |
| VOLUME LEVEL   |   | 4. Enter the 1 <sup>st</sup> digit of the volume setting by clicking the <b>PROGRAM</b> button until the program display shows the desired number. <b>Pause</b> —the radio will sound a low tone and show a hyphen across the center of the display to indicate that it is ready to accept the next digit.  |
|  |   | 5. Enter the 2 <sup>nd</sup> digit of the volume setting by clicking the <b>PROGRAM</b> button until the program display shows the desired number. <b>Pause</b> —the radio sounds a low tone and will show a hyphen across the center of the display to indicate that it is ready to accept the next digit. |
|   | 6. Press and release the <b>ENTER</b> button to save your programming. A triple beep will sound to indicate that programming was successful and a hyphen will appear on the program display. The radio is now ready for another program entry.   |   |
|  | <b>NOTE:</b> An error tone will sound if you attempt to save an incorrect code, an "E" will appear on the display. Check the digits you are attempting to enter, then re-enter.  |   |
|  | 7. Once you have made your final program entry, press the <b>ENTER</b> button a final time to exit programming mode. The Program display will be blank and the radio will be ready for use. The LPA-Series receiver will exit program mode automatically after 30 seconds if no program entries are attempted. |   |

**IMPORTANT NOTE:** Volume settings below 10% are entered as a 2-digit code with a first digit "0".









### Checking the Current Volume Setting

To readout the current volume setting, follow the instructions above and enter a volume setting code "00". When you press the **ENTER** button the radio will immediately begin to display the 2-digit volume setting; with each digit separated by a hyphen.

## 3.7 Program the NOAA Weather Frequency

The LPA-V150 can be programmed to play severe weather warnings originating from the National Weather service that are broadcast on one of seven NOAA weather frequencies. The LPA-Series receiver is shipped from the factory without a NOAA weather frequency selected. Before the Weather Alert feature can be used you must first select the local NOAA frequency.

-  1. Press and **HOLD** the **PROGRAM** button (See [LPA-Series receiver assembly](#) on page 2 for location). A "P" will appear on the program display as you enter program mode and the radio will beep rapidly.
-  2. Release the **PROGRAM** button after the beeping has stopped. The radio will emit a triple beep indicating that the radio is in program mode and a hyphen will appear on the program display.
-  3. Scroll to the character "d" by clicking the **PROGRAM** button until the program display shows the correct character. **Pause**—the radio will sound a low tone and show a hyphen across the center of the display to indicate that it is ready to accept the NOAA Weather Frequency code.
-  4. Enter the Weather Frequency code by clicking the **PROGRAM** button until the program display shows the desired number. **Pause**—the radio sounds a low tone and will begin playing the NOAA weather broadcast over the PA system speakers. Monitor the channel for a few minutes to be sure it is the broadcast for your local area.
-   
 5. Press and release the **ENTER** button to save your programming. A triple beep will sound to indicate that programming was successful and a hyphen will appear on the program display. The radio is now ready for another program entry.  
**NOTE:** An error tone will sound if you attempt to save an incorrect code, an "E" will appear on the display. Check the digits you are attempting to enter, then re-enter.
6. Once you have made your final program entry, press the **ENTER** button a final time to exit programming mode. The Program display will be blank and the radio will be ready for use. The LPA-Series receiver will exit program mode automatically after 30 seconds if no program entries are attempted.

**Table 6: NOAA Weather Frequency Codes**

Code	Frequency
1	162.400 MHz
2	162.425 MHz
3	162.450 MHz
4	162.475 MHz
5	162.500 MHz
6	162.525 MHz
7	162.550 MHz

A complete list of NOAA weather frequencies available in your area can be found at <http://www.weather.gov/nwr/nwrbro.htm>

## 3.8 Field Programming Flow Chart

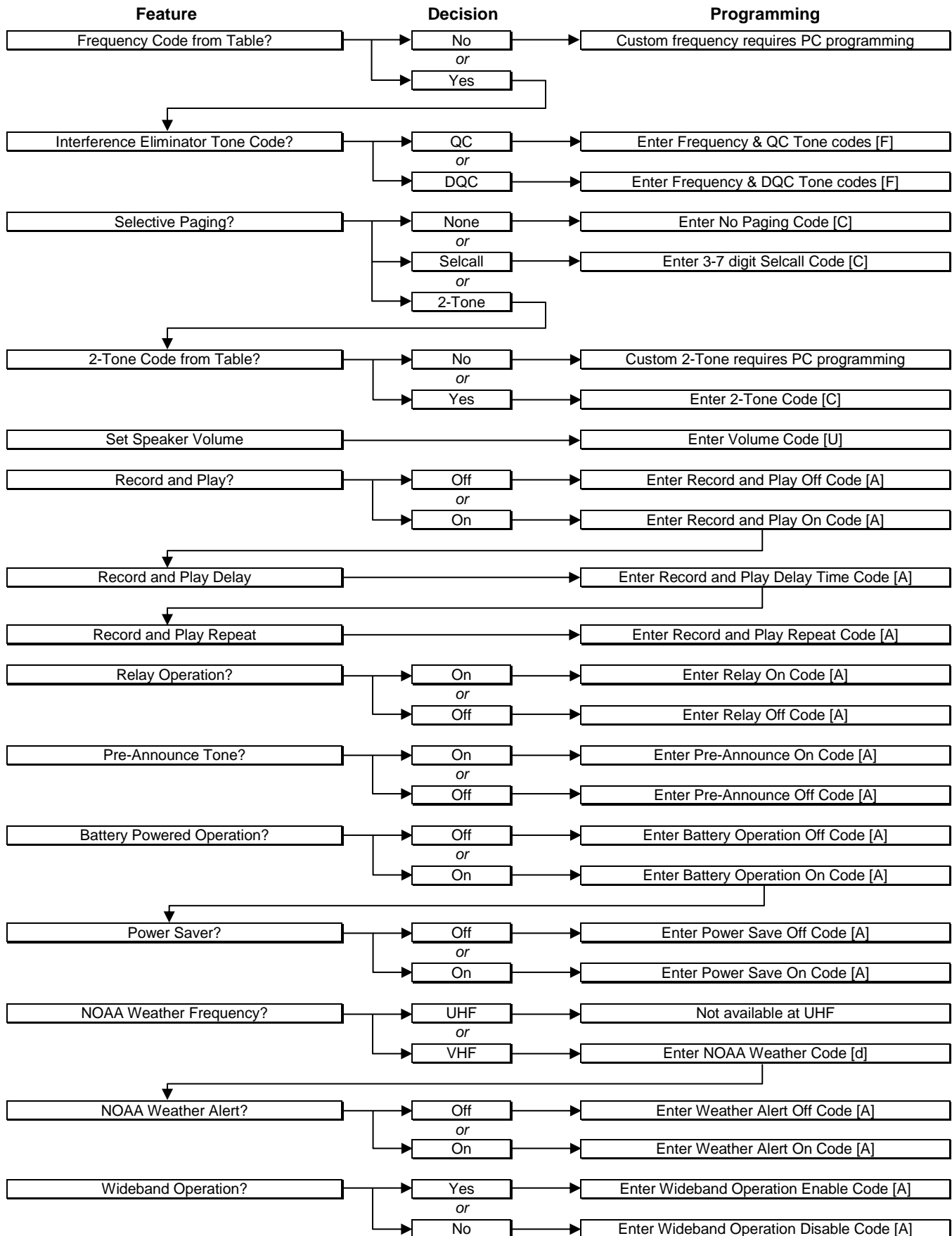

# 4

## Operation

Once installed, operating the LPA-Series radio receiver requires no human contact. Portable, base station or mobile 2-way radios can deliver voice messages directly to a PA system with a simple press of the PTT button for either live or recorded playback. This section describes the subtle differences in operation for various LPA-Series options and installations.

### 4.1 Basic Operation

Basic operation is defined as a LPA-Series receiver programmed on a dedicated radio frequency with a QC or DQC code. The receiver is also programmed for 50% volume and a pre-announce tone.

1. Move to an area that is away from any PA system speaker to prevent feedback.
2. Be sure the microphone on the calling radio is pointed away from any PA system speaker.
3. Set the portable, base station, or mobile radio to the LPA channel.
4. Monitor the channel before transmitting to be sure there are no other radio users on the LPA frequency.
5. Press and hold the PTT button and pause for about 1 second, allowing the pre-announce tone to be heard.
6. Speak into the radio microphone to broadcast your message over the PA system speakers. If other radios are operating on the LPA channel they will also hear your message.
7. Release the PTT button when your message is complete.
8. Return the portable, base station, or mobile radio to the normal operating channel.

### 4.2 Selcall Paging

To access the LPA-Series receiver the 2-way radio must be programmed to send the correct Selcall code every time the PTT is pressed. The user simply presses the 2-way radio's PTT and speaks while on the LPA channel. Only 2-way radios programmed to send the correct Selcall code on the LPA channel can access the PA system.

1. Move to an area that is away from any PA system speaker to prevent feedback.
2. Be sure the microphone on the calling radio is pointed away from any PA system speaker.
3. Set the portable, base station, or mobile radio to the LPA channel.
4. Monitor the channel before transmitting to be sure there are no other radio users on the LPA frequency.
5. Press and hold the PTT button.
6. Wait until the entire Selcall code has been sent, and then an additional 1 second for the pre-announce tone.
7. Speak into the radio microphone to broadcast your message over the PA system speakers. If other radios are operating on the LPA channel they will also hear your message.
8. Release the PTT button when your message is complete.
9. Return the portable, base station, or mobile radio to the normal operating channel.

With Selcall Paging operation:

- Selcall paging can be used in conjunction with QC or DQC for added security. The 2-way radio and the LPA receiver must be programmed for the same QC or DQC code.



## 4.3 2-Tone Paging

To access the LPA-Series receiver the 2-way radio must first send the correct 2-Tone Paging code. Once access to the PA system is accomplished, the user simply presses the 2-way radio's PTT and speaks while on the LPA channel. After a period of inactivity the LPA receiver will automatically reset, and will then require the correct 2-Tone Paging code to re-gain access.

1. Move to an area that is away from any PA system speaker to prevent feedback.
2. Be sure the microphone on the calling radio is pointed away from any PA system speaker.
3. Set the portable, base station, or mobile radio to the LPA channel.
4. Monitor the channel before transmitting to be sure there are no other radio users on the LPA frequency.
5. Send the correct 2-Tone Paging code. Refer to your 2-way radio's user manual to determine how you send 2-tone paging codes.
6. Wait until the entire 2-tone code has been sent.
7. Press and hold the PTT button and pause for about 1 second, allowing the pre-announce tone to be heard.
8. Speak into the radio microphone to broadcast your message over the PA system speakers. If other radios are operating on the LPA channel they will also hear your message.
9. Release the PTT button when your message is complete.
10. If the radio PTT is pressed again before the LPA receiver has reset, the message will be heard on the PA system speakers without the need for a 2-tone Paging code.
11. Return the portable, base station, or mobile radio to the normal operating channel.

### With 2-Tone Paging operation:

- Once LPA receiver has decoded the correct 2-tone code any radio on the LPA channel can talk over the PA system without the need for 2-tone paging.
- After a 2-tone code has been successfully decoded, the programmable Two-Tone Reset Time sets the length of time the LPA receiver can go without receiving a signal before 2-tone is once again required for access. Factory default Two-Tone Reset Time is 5 seconds.
- Can be used in conjunction with QC or DQC for added security. The 2-way radio and the LPA receiver must be programmed for the same QC or DQC code.

## 4.4 Record and Play (30 seconds of record time MAXIMUM)

When 2-way radios are used in the same area as the PA system speakers, feedback may result that can render the system unusable. For those applications the LPA-Series receiver can be programmed to record the incoming messages and play them back over the PA system speakers when the PTT button is released on the 2-way radio. Set the portable, base station, or mobile radio to the LPA channel.

1. Monitor the channel before transmitting to be sure there are no other radio users on the LPA frequency.
2. Press and hold the PTT button on your 2-way radio.
3. Speak into the radio microphone to record your message into the LPA-Series receiver. If other radios are operating on the LPA channel they will hear your message as you record it.
4. Release the PTT button when your message is complete.
5. The pre-announce tone will be heard and the PA system speakers will begin playing your recorded message.
6. When finished, return the portable, base station, or mobile radio to the normal operating channel.

### With Record and Play operation:

- Recorded messages are limited to a maximum of 30 seconds.
- Any of the selective signaling options can be used in conjunction with Record and Play.
- The LPA receiver cannot record (buffer) an incoming message while in the process of playing a message on the speaker.

## 4.5 Weather Alert

VHF model LPA-V150 can automatically play emergency weather warnings from the National Weather Service that is broadcast on one of the seven NOAA weather frequencies. The LPA-V150 will listen for emergency weather broadcasts any time it is not being used. To use this feature the LPA-V150 must first be programmed for your local NOAA weather frequency.

### With Weather Alert operation:

- The Weather Alert feature is only available on the LPA-V150 model.
- Your local NOAA weather frequency must be programmed into the LPA-V150 and the Weather Alert feature must be ON per the instructions in the Programming section of this manual.
- If a severe weather notification from NOAA weather service occurs while the LPA-V150 is in use the Weather Alert operation will not be activated.
- When a severe weather notification from NOAA weather service activates Weather Alert operation, the LPA-V150 will broadcast the NOAA weather alert message non-stop until an end-of-message signal is received or 2 minutes elapses. The LPA-150 cannot be used for regular paging operation as long as the weather alert message is being played.
- The maximum Weather Alert Time is set at the factory for 2 minutes, but is PC programmable from 20 seconds to 4 minutes. This time only matters if an end-of-message signal is not received from NOAA weather service.



**The LPA-Series receiver is not intended for use as a stand-alone weather receiver.**

## 4.6 Battery Powered Operation

For applications where AC power for the RPS-1B is not available, the LPA-Series receiver can be powered by an external +12 VDC battery. The LPA receiver can then be configured for battery powered operation to maximize battery life.

### **Power Save**

Enable this feature whenever the LPA receiver is battery powered to extend battery life. When enabled the LPA receiver is in a low current "sleep" state the majority of the time, waking up periodically to see if there is an incoming message to be broadcast.

- Depending on usage, this may double the battery life.
- The length of time the LPA receiver can "sleep" before it checks for a message is PC programmable from .5 to 8 seconds.
- With Power Save enabled the caller must wait approximately 2 second before speaker to allow the radio to wake up.

### **Low Battery Alert Tone**

Enable this feature whenever the LPA receiver is battery powered and a short tone will be heard at the end of each broadcast to indicate that the batteries need replacement or recharging.

## 4.7 Relay Operation

Radios equipped with a relay that can be set for relay switch closure when the LPA receives a valid signal. The relay can be used to signal the PA Amplifier that a received LPA message is in process.

### **With the Relay Option enabled:**

If Record and Play is disabled	The relay switch will close as soon as a valid signal is received, and will remain closed as long as the signal is present.
If Record and Play is enabled	The relay switch will close as soon as a valid signal is received and will remain closed until the recorded message has finished playing.
If Record and Play Delay is programmed	The relay switch will close as soon as a valid signal is received, and will remain closed for the delay time and until the recorded message has finished playing.
If Recorded Message Replay is programmed	The relay switch will close as soon as a valid signal is received, will remain closed for any Record and Play Delay time and until the recorded message has been repeated in it's entirety.

## 4.8 LPA-Series Options

Certain LPA-Series options affect operation as follows:

### ***Pre-Announce Tone***

With this feature enabled the LPA receiver will sound a short tone prior to each broadcast to notify listeners that a page is forthcoming.

### ***Relay Enable***

For radios equipped with a relay, set this option for relay closure when the LPA receives a valid signal. The relay will remain closed as long as a signal is received. If Record and Play is enabled, the relay will close as soon as a signal is received and remain closed throughout any Record and Play Delay and Recorded Message Replay.

### ***Record and Play Delay***

The playback of a received, recorded message is delayed for the Record and Play Delay time whenever a valid incoming message is received. If the recorded message is longer than the Record and Play Delay time the message plays back at the conclusion of recording. For this feature to work Record and Play must be enabled.

### ***Recorded Message Replay***

Recorded messages are repeated concurrently for the number of times programmed. For this feature to work Record and Play must be enabled.

### ***Field Programming Enable***

With this feature enabled the radio can be programmed via the display and buttons on the radio, without the need for the PC programmer software. Disable this feature to prevent programming in the field and allow only PC programming.

## 4.9 How to Minimize Feedback

Feedback is the result of the PA system speaker audio getting back into the microphone of the radio being used to access the LPA receiver. This is a problem with the calling radio, not the LPA receiver. Although the LPA receiver is not intended to be used in the same area as the calling radio, steps can be taken to minimize the feedback effect.

### ***Reduce LPA receiver speaker volume***

Do not set the LPA receiver volume any high than is necessary to clearly hear the PA messages.

### ***Maintain distance between the calling radio and the PA system speakers***

In general, the calling radio should be at least 50 feet away from the speaker when the LPA receiver is set for 50% volume. The necessary distance increases if the volume is turned up and decreases if the volume is turned down.

### ***Make sure the radio microphone is turned away from the speaker***

You do not want the speaker pointing directly into the microphone. Using your hand to shield the microphone can also reduce feedback.

### ***Use a noise canceling microphone***

Equip your calling radio with an optional noise-canceling microphone.



### **Record and Play feature eliminates feedback**

The Record and Play feature completely eliminates feedback by recording your message and playing it back immediately after you have finished sending it to the LPA receiver. See page 19 to enable the Record and Play operation.

The calling radio is not transmitting while the message is broadcast, so speaker audio cannot get into the calling radio microphone.

# 5

## Specifications

### 5.1 General

Receiver physical dimensions	7.0"H x 5.0"W x 3.0"D	
Receiver enclosure material	Valox® Thermo-plastic	
Receiver color	Gray (RAL# 7035)	
Receiver weight	1 lb. 15 oz. (with AFB-1545 antenna)	
Receiver mounting	top and bottom aluminum bracket	
Receiver environmental	indoor use only	
RELAY	Connectors Output	Screw terminals (1, 2, ground) Switch closure on received signal
AUX	Connector Maximum Output Output Impedance	RCA Phono jack 4 VAC peak (LPA-Series received audio is adjustable) 50kΩ, unbalanced
600Ω MIC OUT	Connectors Maximum Output Output Impedance	Screw terminals (HOT, COLD, ground) 200mVAC peak 600Ω, balanced
DC power connector		2.1mm coaxial DC jack (size M)
Antenna connector		50Ω BNC
Antenna		AFB-1545 dual-band (150-170 MHz, 450-470 MHz)

### 5.2 RPS-1B Power Cube

RPS-1B physical dimensions	2.8" L x 1.34" W. x 2.1" H
RPS-1B mounting	Wall-mounted via 120 VAC plug.
RPS-1B connector	2.1mm coaxial DC plug molded to wire, center conductor = positive
RPS-1B environmental	indoor use only
RPS-1B input voltage	120 VAC, 60 Hz
RPS-1B output voltage	12 VDC @ 1.5A

## 5.3 LPA-Series Receiver

Selective signaling decode capability	<ul style="list-style-type: none"> <li>• CTCSS (Quiet Call)</li> <li>• Digital Coded Squelch (Digital Quiet Call)</li> <li>• Selcall ID</li> <li>• 2-Tone Paging Decode</li> </ul>
Noise squelch sensitivity	Programmable, factory set for 12 dB SINAD
Frequency response	300 - 3000 Hz, de-emphasized
Receiving System	Dual conversion superheterodyne
I.F. System	1st .....43.65 MHz 2nd .....450 kHz
QC/DQC decode time	per EIA Standards
2-Tone decode frequency range	300 – 1500 Hz
Selcall decode standard	EEA tone set, 3-7 digits

	LPA-U450		LPA-V150	
FCC ID	AIERIT27-450		AIERIT27-150	
IC ID	1084A-RIT27450		1084A-RIT27150	
Frequency range	450 - 470 MHz		150 – 165 MHz	
Synthesizer steps	6.25 kHz		2.5 kHz	
Frequency stability	+/-1.5 PPM (-30° to +60° C)		+/-2.5 PPM (-30° to +60° C)	
Modulation acceptance	wide	+/- 5.0 kHz	wide	+/- 5.0 kHz
	narrow	+/- 3.75 kHz	narrow	+/- 3.75 kHz
Typical sensitivity (12 dB SINAD)	wide	0.15 $\mu$ V (-123 dBm)	wide	0.16 $\mu$ V (-123 dBm)
	narrow	0.19 $\mu$ V (-121 dBm)	narrow	0.18 $\mu$ V (-122 dBm)
L.O. Injection	RX frequency – 43.65 MHz		RX frequency + 43.65 MHz	
Adjacent Channel (EIA)	wide	-70 dB	wide	-70 dB
	narrow	-60 dB	narrow	-60 dB
Spurious rejection	wide	-70 dB	wide	-70 dB
	narrow	-60 dB	narrow	-60 dB
Image rejection (EIA)	wide	-60 dB	wide	-80 dB
	narrow	-60 dB	narrow	-80 dB
Intermodulation (EIA)	wide	-65 dB	wide	-65 dB
	narrow	-65 dB	narrow	-65 dB
QC/DQC decode deviation requirement	wide	500 – 850 Hz	wide	500 – 850 Hz
	narrow	350 – 500 Hz	narrow	350 – 500 Hz
2-Tone decode deviation requirement	wide	2.5 – 3.5 kHz	wide	2.5 – 3.5 kHz
	narrow	1.5 – 2.5 kHz	narrow	1.5 – 2.5 kHz

**NOTE:** The manufacturer is not responsible for any radio or TV interference caused by unauthorized modifications to this equipment. Such modifications could void the user's authority to operate the equipment.

# 6

## Warranty

### WHAT THIS WARRANTY COVERS:

RITRON, INC. ("RITRON") provides the following warranty against defects in materials and/or workmanship in **RITRON Radios and Accessories** under normal use and service during the applicable warranty period (as stated below). "Accessories" means antennas, power cubes, and items contained in the programming and programming/service kits.

<u>WHAT IS COVERED</u>	<u>FOR HOW LONG</u>	<u>WHAT RITRON WILL DO</u>
LPA Radio Receiver	1 year*	During the first year after date of purchase, RITRON will repair or replace the defective product, at RITRON's option, parts and labor
Accessories	90 days*	*After date of purchase

### WHAT THIS WARRANTY DOES NOT COVER:

- Any technical information provided with the covered product or any other RITRON products;
- Installation, maintenance or service of the product, unless this is covered by a separate written agreement with RITRON;
- Any products not furnished by RITRON which are attached or used with the covered product, or defects or damage from the use of the covered product with equipment that is not covered (such as defects or damage from the charging or use of batteries other than with covered product);
- Defects or damage, including broken antennas, resulting from:
  - misuse, abuse, improper maintenance, alteration, modification, neglect, accident or act of God,
  - the use of covered products other than in normal and customary manner or,
  - improper testing or installation;
- Defects or damages from unauthorized disassembly, repair or modification, or where unauthorized disassembly, repair or modification prevents inspection and testing necessary to validate warranty claims;
- Defects or damages in which the serial number has been removed, altered or defaced.
- Batteries if any of the seals are not intact.

**IMPORTANT:** This warranty sets forth the full extent of RITRON's express responsibilities regarding the covered products, and is given in lieu of all other express warranties. What RITRON has agreed to do above is your sole and exclusive remedy. No person is authorized to make any other warranty to you on behalf of RITRON. Warranties implied by state law, such as implied warranties of merchantability and fitness for a particular purpose, are limited to the duration of this limited warranty as it applies to the covered product. Incidental and consequential damages are not recoverable under this warranty (this includes loss of use or time, inconvenience, business interruption, commercial loss, lost profits or savings). Some states do not allow the exclusion or limitation of incidental or consequential damages, or limitation on how long an implied warranty lasts, so the above limitations or exclusions may not apply to you. Because each covered product system is unique, RITRON disclaims liability for range, coverage, or operation of the system as a whole under this warranty.

**WHO IS COVERED BY THIS WARRANTY:** This warranty is given only to the purchaser or lessee of covered products when acquired for use, not resale. This warranty is not assignable or transferable.

**HOW TO GET WARRANTY SERVICE:** To receive warranty service, you must deliver or send the defective product, delivery costs and insurance prepaid, within the applicable warranty period, to **RITRON, INC., 505 West Carmel Drive, Carmel, Indiana 46032, Attention: Warranty Department**. Please point out the nature of the defect in as much detail as you can. You must retain your sales or lease receipt (or other written evidence of the date of purchase) and deliver it along with the product. If RITRON chooses to repair or replace a defective product, RITRON may replace the product or any part or component with reconditioned product, parts or components. Replacements are covered for the balance of the original applicable warranty period. All replaced covered products, parts or components become RITRON's property.

**RIGHTS TO SOFTWARE RETAINED :** Title and all rights or licenses to patents, copyrights, trademarks and trade secrets in any RITRON software contained in covered products are and shall remain in RITRON. RITRON nevertheless grants you a limited non-exclusive, transferable right to use the RITRON software only in conjunction with covered products. No other license or right to the RITRON software is granted or permitted.

**YOUR RIGHTS UNDER STATE LAW:** This warranty gives you specific legal rights, and you may also have other rights which vary from state to state.

**WHERE THIS WARRANTY IS VALID: THIS WARRANTY IS VALID ONLY WITHIN THE UNITED STATES, THE DISTRICT OF COLUMBIA AND PUERTO RICO.**